

8 7 6 5 4 3 2 1

D

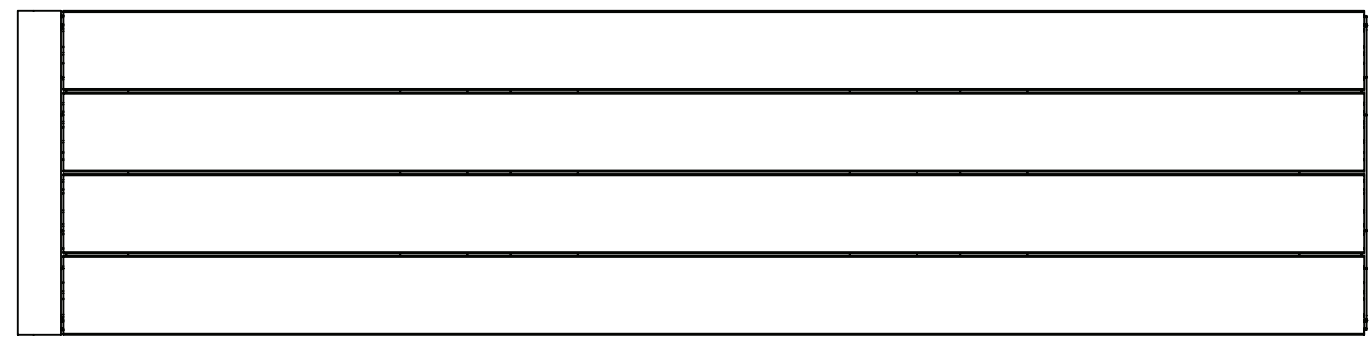

TOP VIEW - ALUMINUM SLAT

C

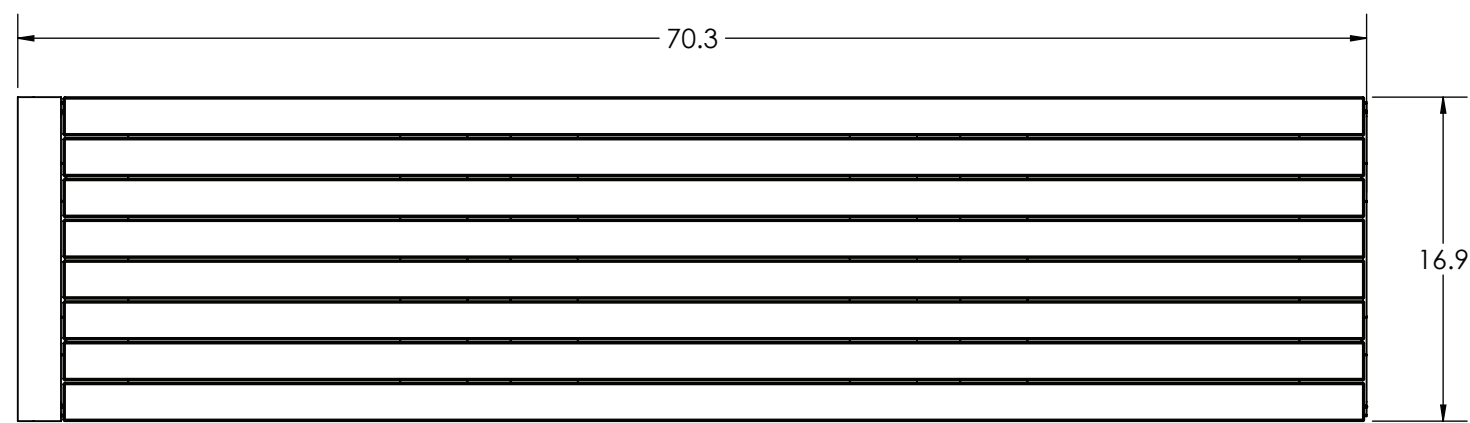

TOP VIEW - WOOD SLAT

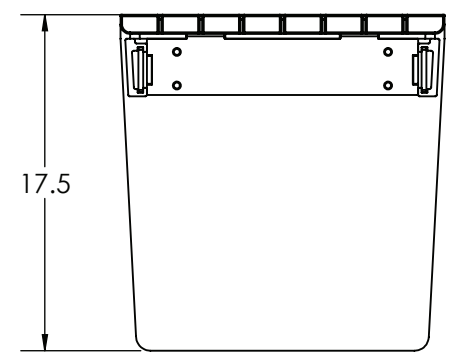

RIGHT VIEW

B

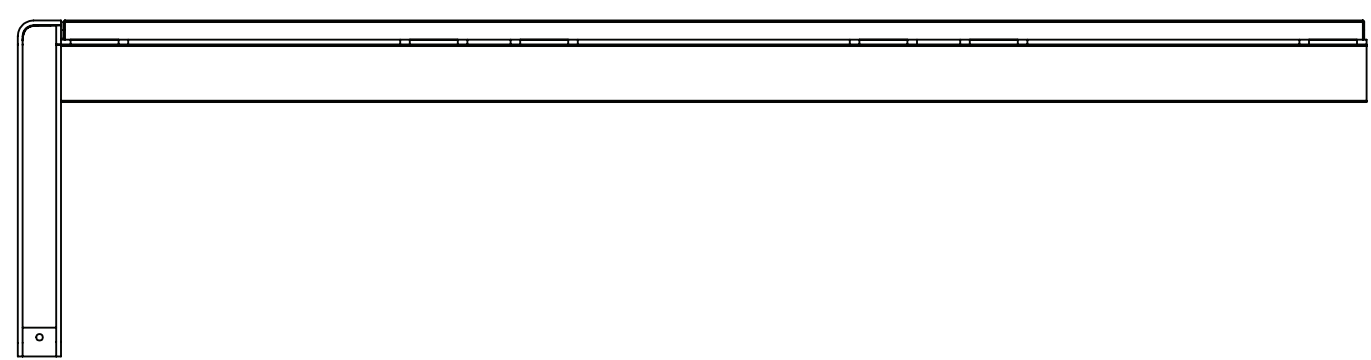

FRONT VIEW

CUSTOMER APPROVAL:

X \_\_\_\_\_

DATE:

X \_\_\_\_\_

A

UNLESS OTHERWISE SPECIFIED, DIMENSIONS ARE IN INCHES		<b>FORMS+SURFACES</b> ® 30 Pine Street, Pittsburgh, PA 15223 Tel (412) 781-9003 Fax (412) 781-7840	
TOLERANCES (UNLESS OTHERWISE SPECIFIED): FRACTIONAL: ±1/32 ANGULAR/BEND: ±1° TWO PLACE DECIMAL ±.030 THREE PLACE DECIMAL ±.020		NAME	DATE
MATERIAL: SEE DATA SHEET		DWN	MGJ 11/3/2014
FINISH: SEE DATA SHEET		DO NOT SCALE DRAWING	
WEIGHT: 52.90 LBS.		PROPRIETARY AND CONFIDENTIAL	
SOURCE: -		THE INFORMATION CONTAINED IN THIS DRAWING IS THE SOLE PROPERTY OF FORMS + SURFACES. ANY REPRODUCTION IN PART OR AS A WHOLE WITHOUT WRITTEN PERMISSION IS PROHIBITED.	
SCALE: N.T.S.		SIZE	DWG. NO.
		B	SBVTR-72-1E-0B
		REV	SHEET
		0	1 OF 1

8 7 6 5 4 3 2 1

D

C

B

A

PRINTED: 11/5/2014

8 7 6 5 4 3 2 1

D

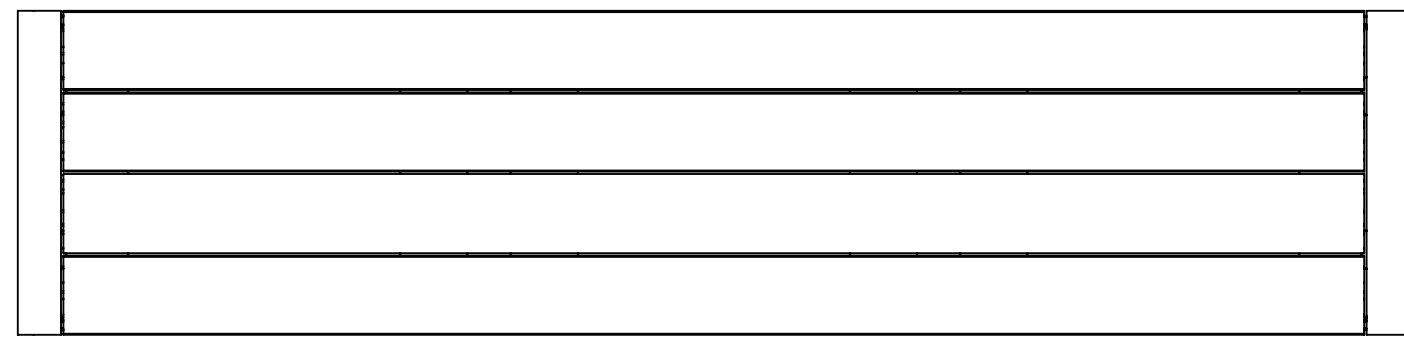

TOP VIEW - ALUMINUM SLAT

C

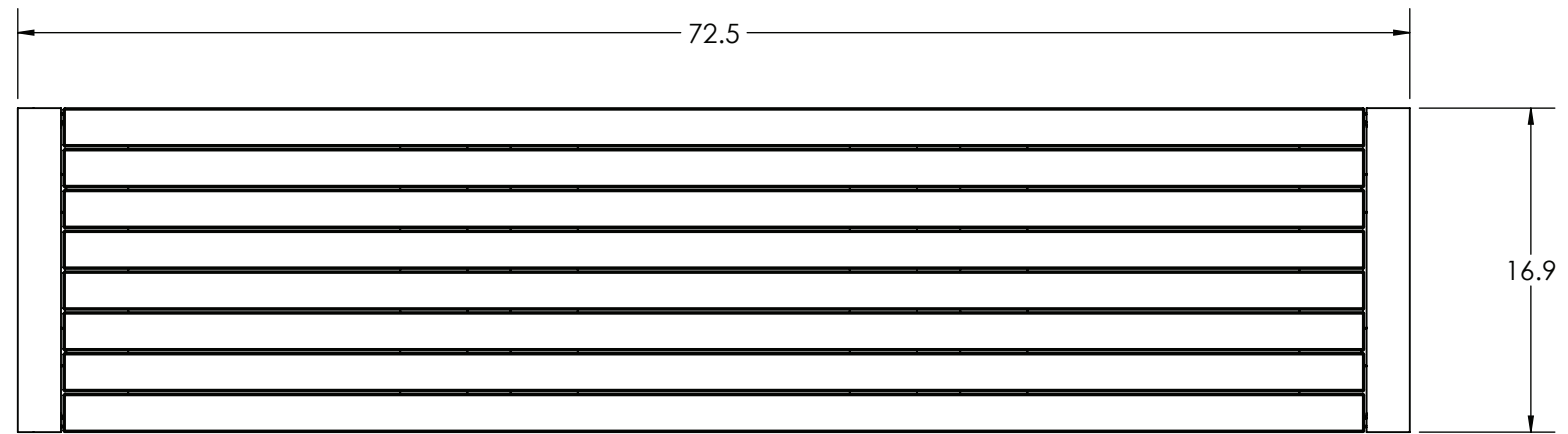

TOP VIEW - WOOD SLAT

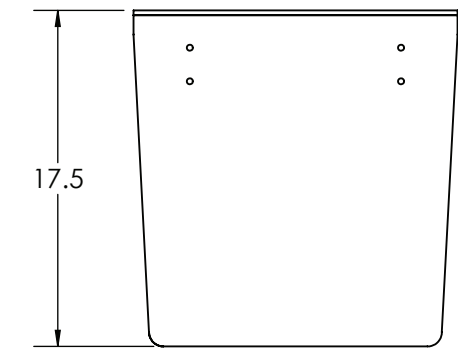

RIGHT VIEW

B

CUSTOMER APPROVAL:

X \_\_\_\_\_

DATE:

X \_\_\_\_\_

A

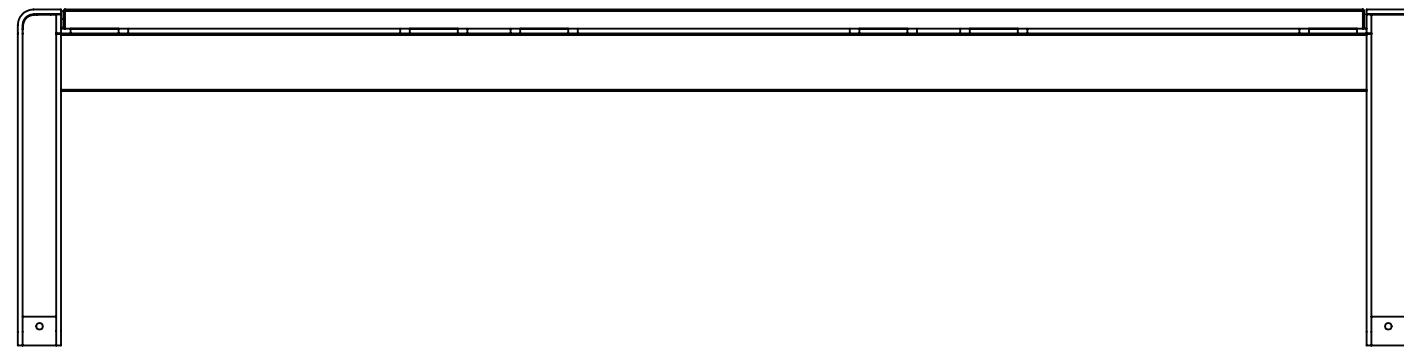

FRONT VIEW

UNLESS OTHERWISE SPECIFIED, DIMENSIONS ARE IN INCHES		<b>FORMS+SURFACES</b> ® 30 Pine Street, Pittsburgh, PA 15223 Tel (412) 781-9003 Fax (412) 781-7840	
TOLERANCES (UNLESS OTHERWISE SPECIFIED): FRACTIONAL: ±1/32 ANGULAR/BEND: ±1° TWO PLACE DECIMAL ±.030 THREE PLACE DECIMAL ±.020		NAME	DATE
MATERIAL: SEE DATA SHEET		DWN	MGJ 11/3/2014
FINISH: SEE DATA SHEET		DO NOT SCALE DRAWING	
WEIGHT: 52.90 LBS.		PROPRIETARY AND CONFIDENTIAL	
SOURCE: -		THE INFORMATION CONTAINED IN THIS DRAWING IS THE SOLE PROPERTY OF FORMS + SURFACES. ANY REPRODUCTION IN PART OR AS A WHOLE WITHOUT WRITTEN PERMISSION IS PROHIBITED.	
SCALE: N.T.S.		SIZE	DWG. NO.
		B	SBVTR-72-1E1M-0B
		REV	SHEET
		0	1 OF 1

8 7 6 5 4 3 2 1

D

C

B

A

PRINTED: 11/5/2014

8 7 6 5 4 3 2 1

D

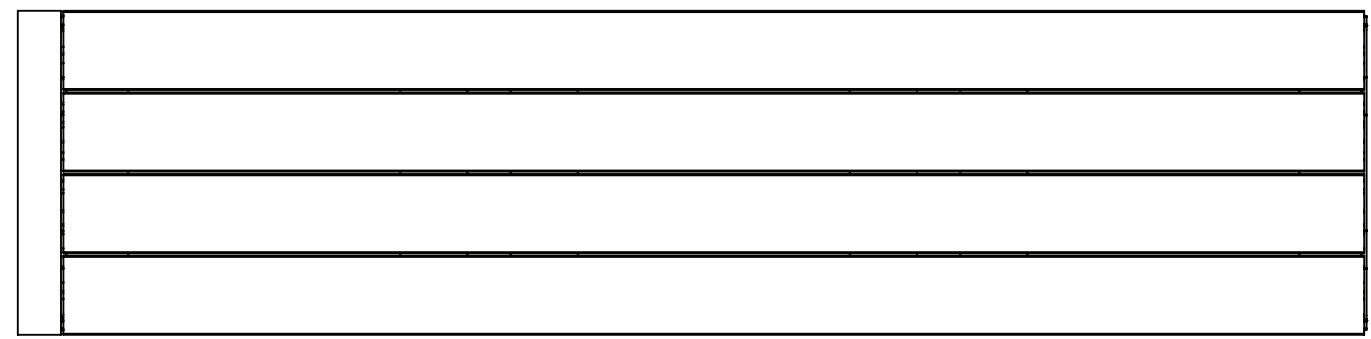

TOP VIEW - ALUMINUM SLAT

C

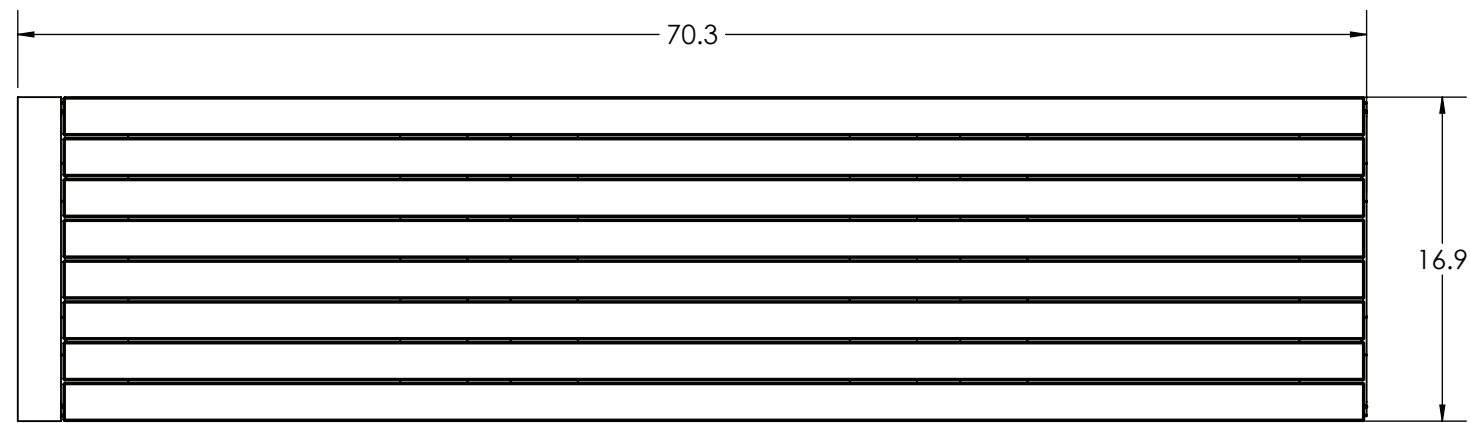

TOP VIEW - WOOD SLAT

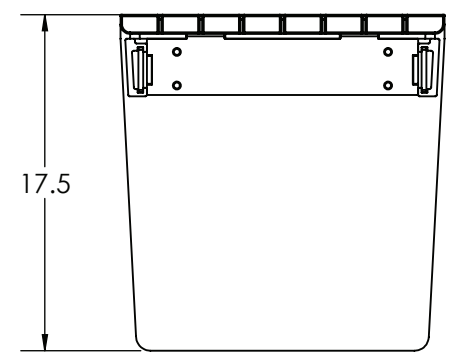

RIGHT VIEW

B

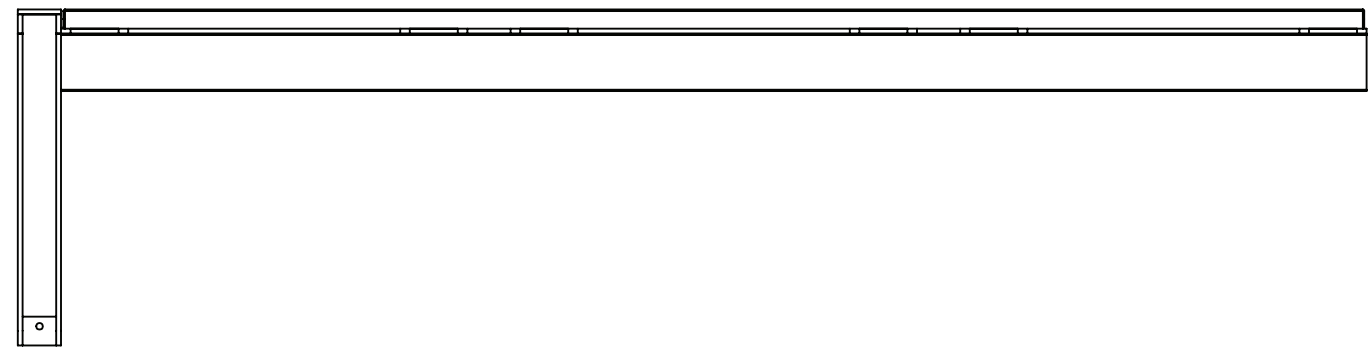

FRONT VIEW

CUSTOMER APPROVAL:

X \_\_\_\_\_

DATE:

X \_\_\_\_\_

UNLESS OTHERWISE SPECIFIED,  
DIMENSIONS ARE IN INCHES  
TOLERANCES (UNLESS OTHERWISE SPECIFIED):  
FRACTIONAL: ±1/32  
ANGULAR/BEND: ±1°  
TWO PLACE DECIMAL ±.030  
THREE PLACE DECIMAL ±.020  
MATERIAL: SEE DATA SHEET  
FINISH: SEE DATA SHEET  
WEIGHT: 52.90 LBS.  
SOURCE: -  
SCALE: N.T.S.

**FORMS+SURFACES**® 30 Pine Street, Pittsburgh, PA 15223  
Tel (412) 781-9003 Fax (412) 781-7840

NAME	DATE
DWN	MGJ 11/3/2014

VECTOR SEATING SYSTEM  
6 FOOT, ONE INTERMEDIATE LEG  
SBVTR-72A-1M-0B  
SBVTR-72C-1M-0B

SIZE	DWG. NO.	REV	SHEET
B	SBVTR-72-1M-0B	0	1 OF 1

A

PRINTED: 11/5/2014

8 7 6 5 4 3 2 1

8 7 6 5 4 3 2 1

D

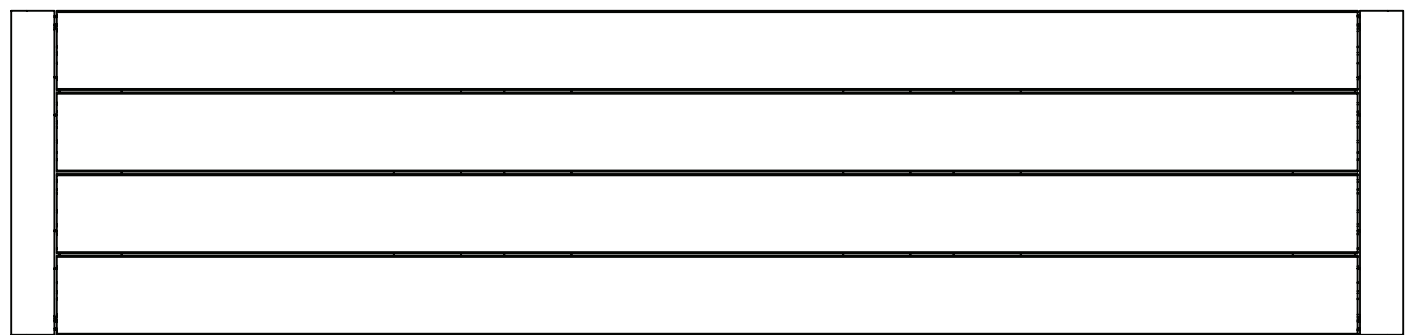

TOP VIEW - ALUMINUM SLAT

C

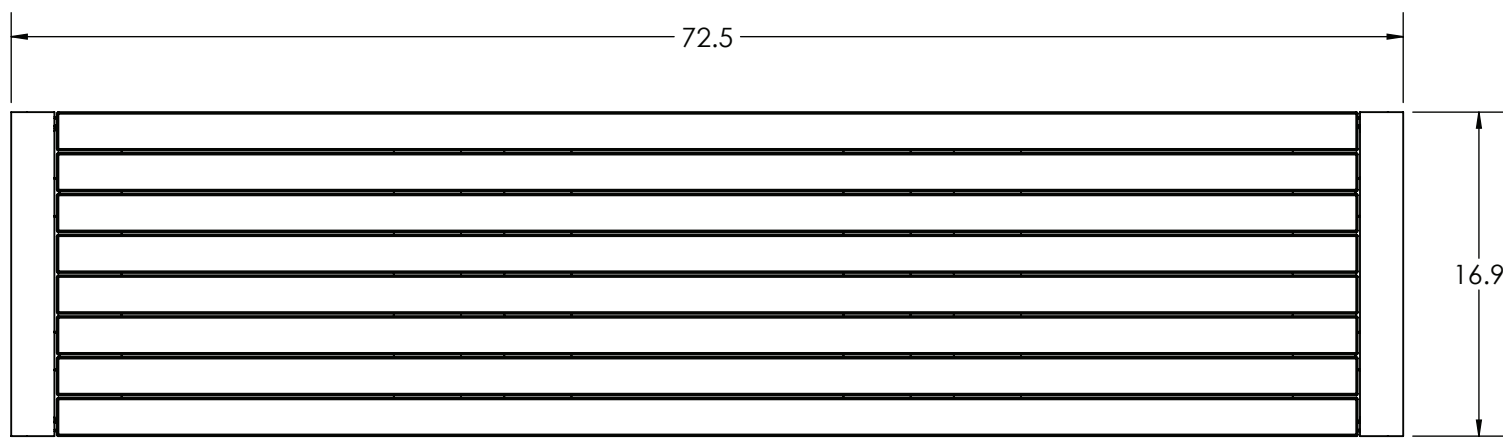

TOP VIEW - WOOD SLAT

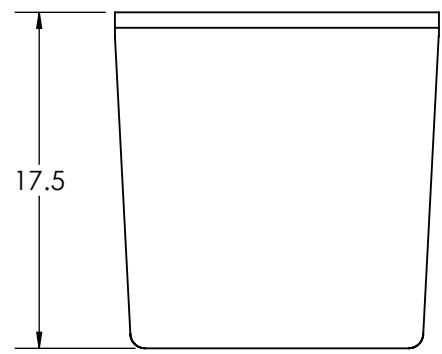

RIGHT VIEW

B

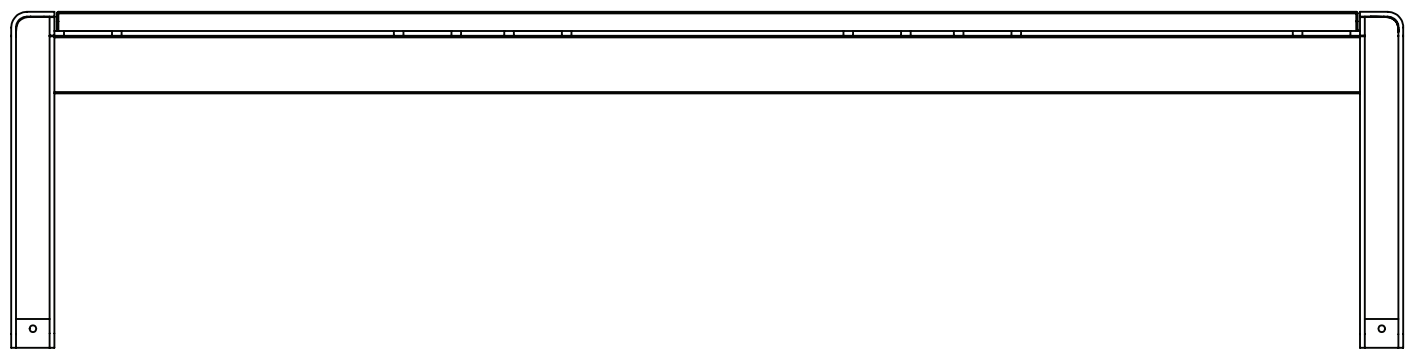

FRONT VIEW

CUSTOMER APPROVAL:

X \_\_\_\_\_

DATE:

X \_\_\_\_\_

UNLESS OTHERWISE SPECIFIED, DIMENSIONS ARE IN INCHES		<b>FORMS+SURFACES</b> ® 30 Pine Street, Pittsburgh, PA 15223 Tel (412) 781-9003 Fax (412) 781-7840	
TOLERANCES (UNLESS OTHERWISE SPECIFIED): FRACTIONAL: ±1/32 ANGULAR/BEND: ±1°* TWO PLACE DECIMAL ±.030 THREE PLACE DECIMAL ±.020		NAME	DATE
MATERIAL: SEE DATA SHEET		DWN	MGJ 11/04/2014
FINISH: SEE DATA SHEET		DO NOT SCALE DRAWING	
WEIGHT: 160.92 LBS.		PROPRIETARY AND CONFIDENTIAL	
SOURCE: -		THE INFORMATION CONTAINED IN THIS DRAWING IS THE SOLE PROPERTY OF FORMS + SURFACES. ANY REPRODUCTION IN PART OR AS A WHOLE WITHOUT WRITTEN PERMISSION IS PROHIBITED.	
SCALE: N.T.S.		SIZE	DWG. NO.
		B	SBVTR-72-2E-0B
		REV	SHEET
		0	1 OF 1

8 7 6 5 4 3 2 1

D

C

B

A

PRINTED: 11/05/2014

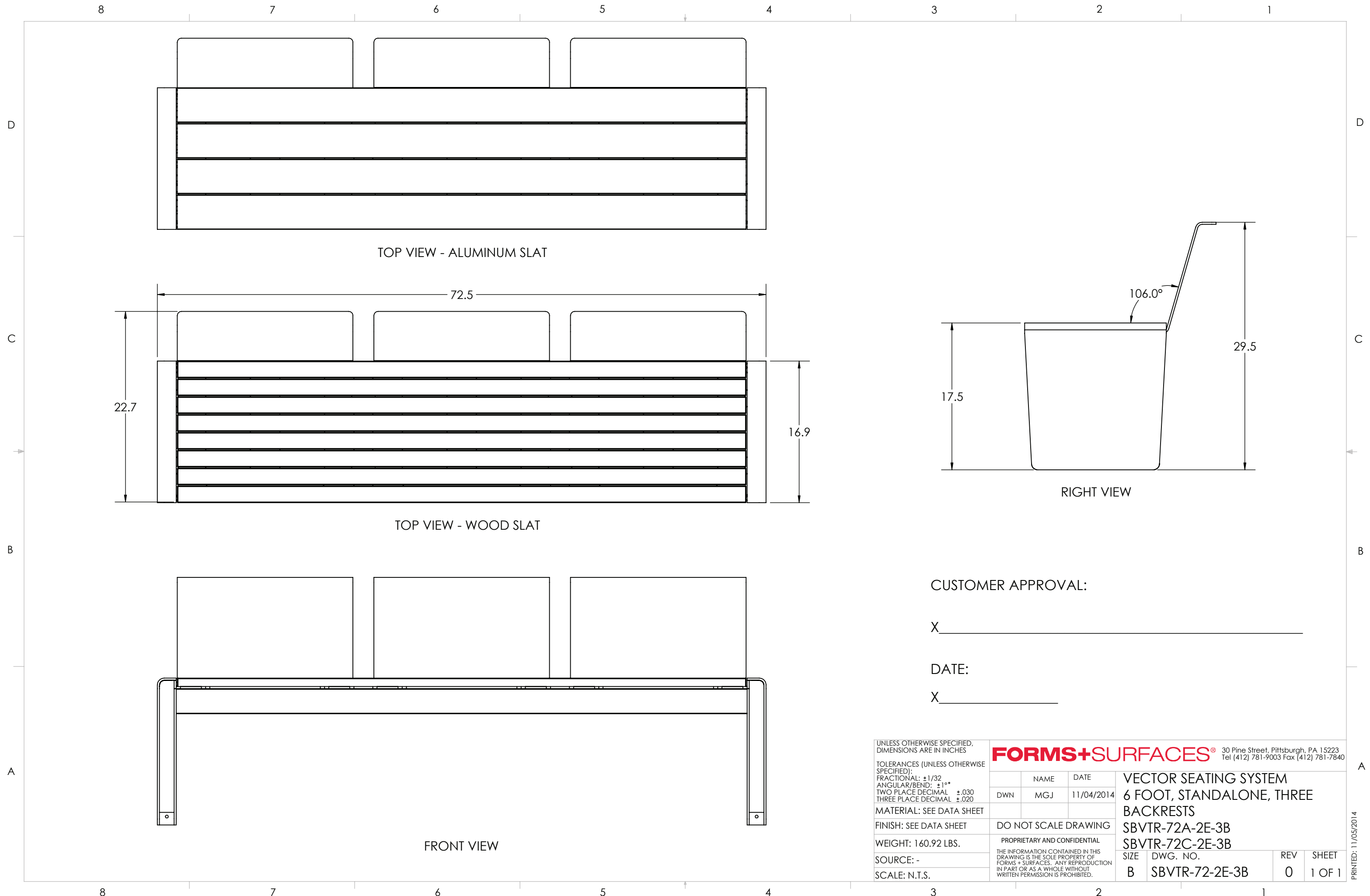

TOP VIEW - ALUMINUM SLAT

TOP VIEW - WOOD SLAT

RIGHT VIEW

FRONT VIEW

CUSTOMER APPROVAL:

X \_\_\_\_\_

DATE:

X \_\_\_\_\_

UNLESS OTHERWISE SPECIFIED, DIMENSIONS ARE IN INCHES		<b>FORMS+SURFACES</b> ® 30 Pine Street, Pittsburgh, PA 15223 Tel (412) 781-9003 Fax (412) 781-7840	
TOLERANCES (UNLESS OTHERWISE SPECIFIED): FRACTIONAL: ±1/32 ANGULAR/BEND: ±1° TWO PLACE DECIMAL ±.030 THREE PLACE DECIMAL ±.020		NAME	DATE
MATERIAL: SEE DATA SHEET		DWN	MGJ 11/04/2014
FINISH: SEE DATA SHEET		DO NOT SCALE DRAWING	
WEIGHT: 160.92 LBS.		PROPRIETARY AND CONFIDENTIAL	
SOURCE: -		THE INFORMATION CONTAINED IN THIS DRAWING IS THE SOLE PROPERTY OF FORMS + SURFACES. ANY REPRODUCTION IN PART OR AS A WHOLE WITHOUT WRITTEN PERMISSION IS PROHIBITED.	
SCALE: N.T.S.		SIZE	DWG. NO.
		B	SBVTR-72-2E-3B
		REV	SHEET
		0	1 OF 1

PRINTED: 11/05/2014