



LEVELr™ ELEVATOR INTERIORS

PRODUCT DATA





LEVELr™ ELEVATOR INTERIORS

PRODUCT DATA

LEVELr Elevator Interiors bring sophisticated design possibilities to a configurable panelized system that offers a frameless panel aesthetic, diverse material options from the F+S Surfaces library, and a variety of trim, reveal, and LED details that heighten the fit and finish of the end design. Individual LEVELr panels consist of a decorative face material bonded to a fire-rated substrate. Because the panels don't have visible frames, they can create nearly uninterrupted surface continuity within the cab interior—a refinement that adds to the system's elegance. Five primary wall panel configurations, each with variations, ensure countless design opportunities. Furthering LEVELr's appeal, LEVELr Elevator Interiors coordinate with our LEVELr Wall Cladding and LEVELr Column Systems.

Beyond LEVELr, the F+S Elevator Interiors program gives you unparalleled creative freedom for meeting the aesthetic, performance and budgetary requirements of virtually any environment. Ideal for new or modernization projects, the program includes three distinct families that suit diverse field conditions without sacrificing ease of specification, installation, maintenance, or breadth of material choices. Learn more about the entire program on our website.

SYSTEM COMPONENTS

Standard: Wall Panels, Bases, Reveals, Perimeter Fins, Installation Hardware

Optional: Handrails, Crash Rails, Elevator Ceiling with Light Fixtures and Emergency Lighting Power Source

SYSTEM COMPONENTS MAP

LEVELr-201D configuration shown.

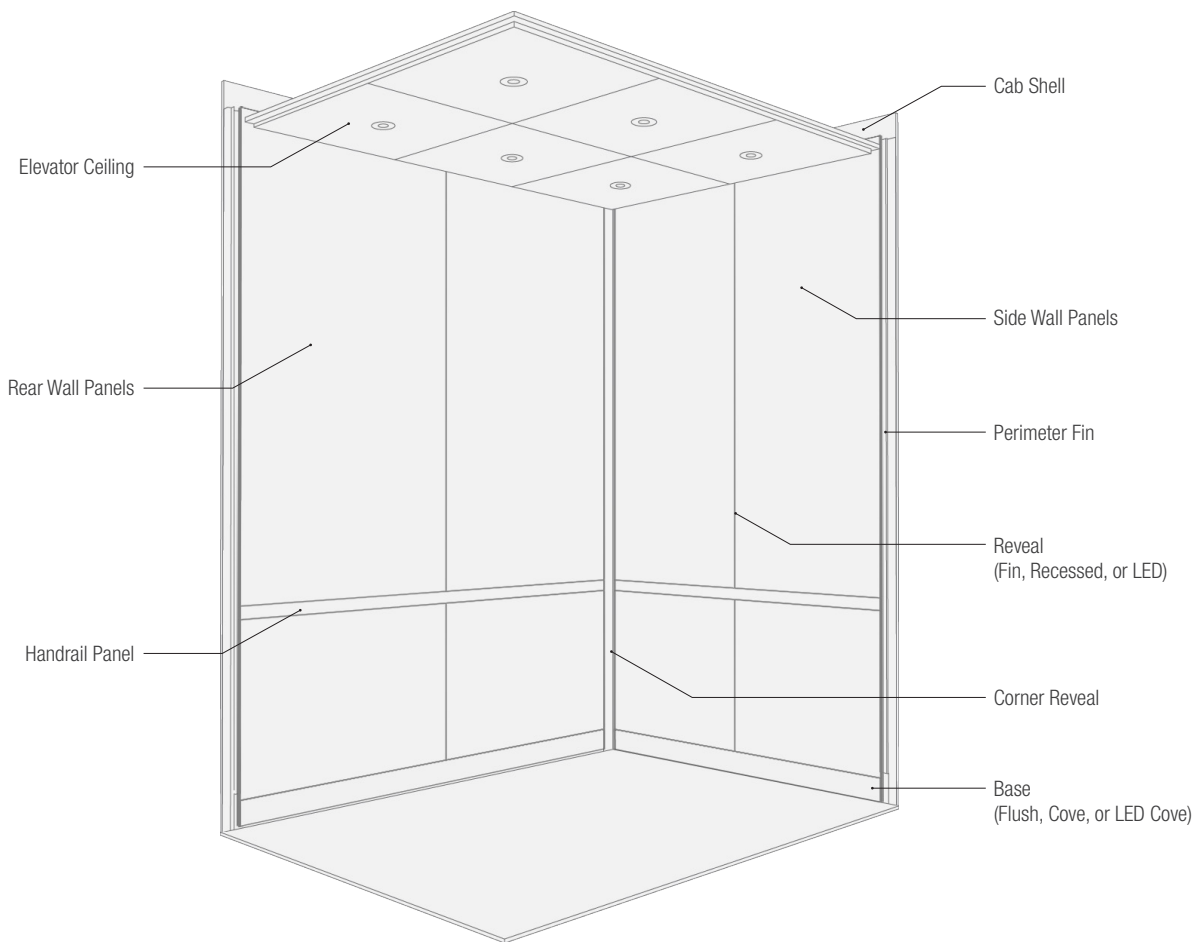



STANDARD INSET MATERIAL OPTIONS

VIVIDGLASS	STAINLESS STEEL	FUSED METAL
VividGlass laminated glass has tremendous creative potential. Offering numerous ways to transform spaces with colors, patterns and graphics, many of our VividGlass designs can be specified as wall panel insets including selections from our ViviChrome, ViviGraphix, ViviSpectra, ViviStone, ViviStrata and ViviTela families. Please refer to the individual VividGlass Product Data Sheets for swatches and additional information.	Stainless Steel in all of our standard finishes can be specified for panel insets. A variety of optional patterns, can also be specified for added visual interest and enhanced functionality. Impression patterns bring dimension to the surface; eco-friendly Eco-Etch® patterns offer standard and custom options. Please refer to the Stainless Steel Product Data Sheet for finish and pattern swatches and additional information.	Fused Metal is Forms+Surfaces' exclusive line of colored stainless steel. Created by fusing titanium alloys to the stainless substrate at the molecular level, Fused Metal provides the durability and low maintenance of stainless steel in a rich range of colors. Please refer to the Fused Metal Product Data Sheet for color, finish, and pattern swatches and additional information.
BONDED METAL	BONDED QUARTZ	WOOD VENEER
Bonded Metal castings are light in weight yet extremely durable. The material's high relief, highly detailed surfaces have the character and appearance of solid metal. A wide range of patterns, metal colors and patinas offer a striking breadth of design possibilities. Please refer to the Bonded Metal Product Data Sheet for complete information.	Bonded Quartz combines ceramic microspheres and a fiber-reinforced polymer matrix to form a material that is lightweight, durable and easy to clean. Standard colors are White and Charcoal; custom colors are also available. A variety of sculptural patterns complete the design options. Please refer to the Bonded Quartz Product Data Sheet for complete information.	All veneers are finished with three coats of CAB acrylic lacquer for superior abrasion resistance and non-yellowing performance while maintaining the richness and authenticity of genuine wood. Please refer to the Wood Veneer Product Data Sheet for material options and additional information.

MATERIAL OPTIONS PER PANEL TYPE

	LEVELr PANEL	F+S ELEVATOR CEILINGS*
VIVIDGLASS	•	
STAINLESS STEEL	•	•
FUSED METAL	•	•
BONDED METAL	•	
BONDED QUARTZ	•	
WOOD VENEER	•	
THIRD PARTY INSET MATERIALS	Customers sometimes wish to specify their own inset materials to match lobby walls or other areas on specific projects. This is generally feasible, provided the materials meet certain weight and dimensional requirements. Please call for more information.	

*Refer to pages 8-9 for more information or to the Elevator Ceilings Product Data Sheet for complete details.



LEVELr™ ELEVATOR INTERIORS

PRODUCT DATA

STANDARD CONFIGURATIONS

LEVELr Elevator Interiors are available in five standard configurations. All can be configured using the **Elevator Design Studio**, our interactive online design tool that puts creative control at your fingertips. The intuitive, step-by-step format lets you choose an elevator interior configuration, apply materials and finishes from our extensive Surfaces library, view your progress in realistic renderings, and request budget pricing – all with a few simple clicks. Visit www.elevatordesignstudio.com to give it a try and see how easy it is.

LEVELr-201

Each wall of the LEVELr-201A consists of equal sized vertical panels.

LEVELr-201B, C & D variations offer alternate wall panel and handrail panel treatments.

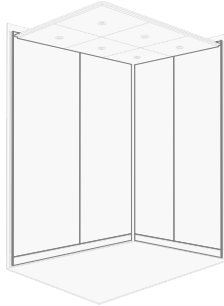

LEVELr-201A

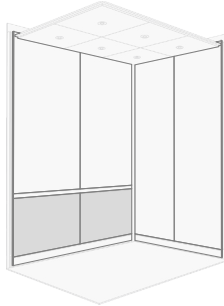

LEVELr-201B

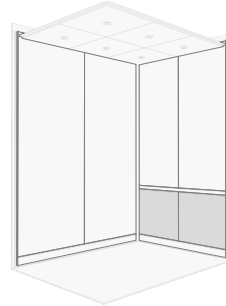

LEVELr-201C

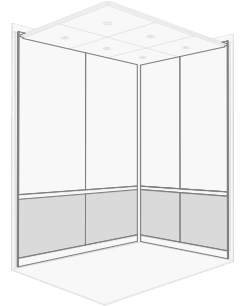

LEVELr-201D

LEVELr-202

Each wall of the LEVELr-202A consists of vertical panels in varying sizes.

LEVELr-202B, C & D variations offer alternate wall panel and handrail panel treatments.

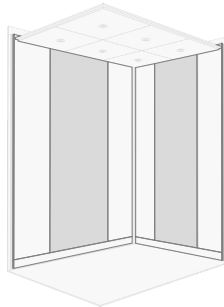

LEVELr-202A

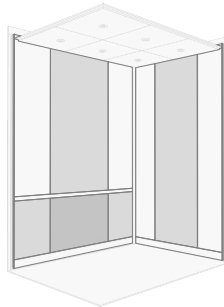

LEVELr-202B

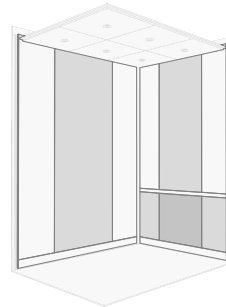

LEVELr-202C

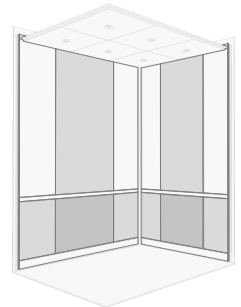

LEVELr-202D

LEVELr-203

Each wall of the LEVELr-203A consists of equal sized vertical panels.

LEVELr-203B, C & D variations offer alternate wall panel and handrail panel treatments.

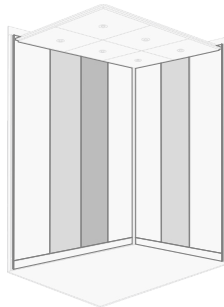

LEVELr-203A

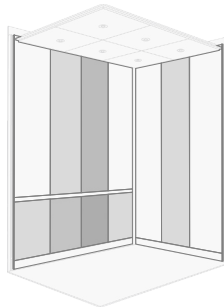

LEVELr-203B

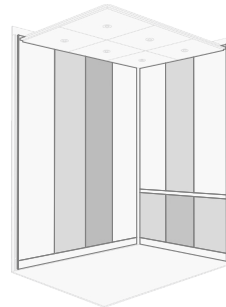

LEVELr-203C

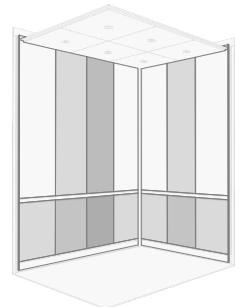

LEVELr-203D



LEVELr™ ELEVATOR INTERIORS

PRODUCT DATA

LEVELr-204

Each wall of the LEVELr-204A consists of horizontal panels in similar sizes.

LEVELr-204B, C & D variations offer alternate handrail panel treatments.

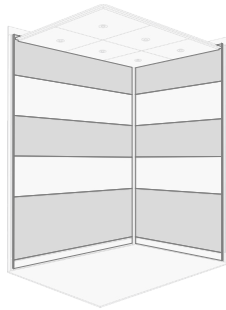

LEVELr-204A

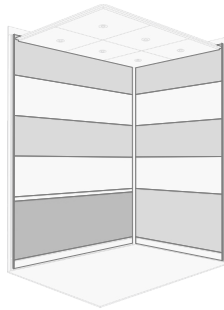

LEVELr-204B

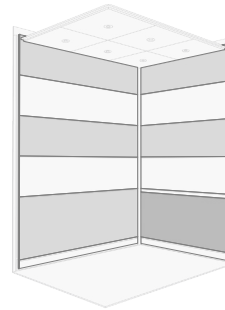

LEVELr-204C

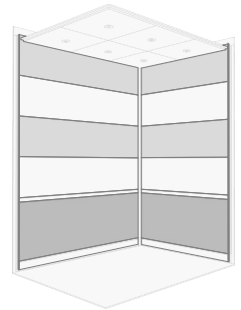

LEVELr-204D

LEVELr-205

The back wall of the LEVELr-205A consists of horizontal panels book-ended by vertical accent panels.

LEVELr-205B, C & D variations offer alternate wall panel and handrail panel treatments.

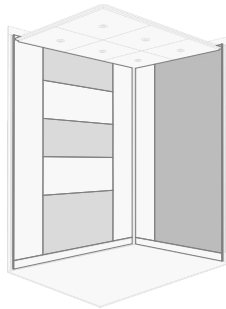

LEVELr-205A

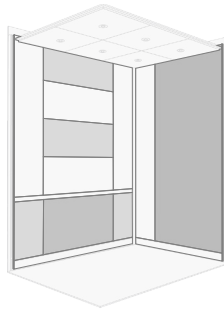

LEVELr-205B

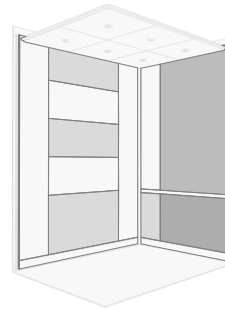

LEVELr-205C

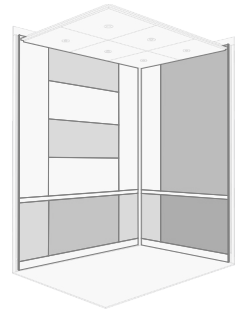

LEVELr-205D

CUSTOM

Contact us for more information on custom configurations and design options.

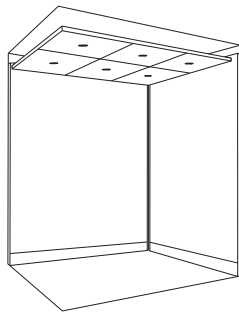

COMPATIBILITY & WEIGHT

SHELL COMPATIBILITY	WEIGHT INFORMATION
<ul style="list-style-type: none"> LEVELr Elevator Interiors can be specified for elevators of any size, weight capacity, or door configuration. Most interiors are installed in steel elevator shells but can also be supplied with appropriate screws for installation in wood shells. Most elevator shells are found to be out-of-square to some degree. LEVELr wall panels and corner reveals have sufficient tolerances built into them to easily accommodate the vast majority of out-of-square conditions or other dimensional irregularities. 	<ul style="list-style-type: none"> LEVELr Elevator Interior panels weigh up to approximately 2-3 lbs. per square foot depending on the material selected, with the exception of glass, which is approximately 5.25 lbs. per square foot. Ceilings (including lights and structural elements) weigh approximately 2.97 lbs. per square foot. Handrail and crash rail weights vary by series and length. Estimated total weights for customer-specified cab interiors can be provided by Forms+Surfaces once shell dimensions, material selections and other system options are specified.



SYSTEM COMPONENTS

WALL PANELS	
<ul style="list-style-type: none"> • Panels have no visible frames and consist of a decorative face material bonded to a fire-rated structural substrate (when glass is the face material, there's no structural substrate; the suspension system is adhered directly to the back of the glass). • The extrusions that comprise the panel substrate are structural and standard in black anodized aluminum. 	

PANEL REVEALS		
<p>Three styles of Panel Reveals, all 0.25" wide, are designed to fit between the wall panels. Each brings a different visual finish to the overall cab design. Reveals can be specified to run between the panels in vertical and/or horizontal orientations, as noted below.</p>		
<p>Panel Recessed Reveal Panel</p>	<p>Panel Fin Reveal Panel</p>	<p>Panel LED Lit Reveal Panel</p>
RECESSED REVEAL	FIN REVEAL	LED LIT REVEAL*
<ul style="list-style-type: none"> • Recessed Reveals sit just below the panel face and are available in Black. • Recessed Reveals allow for an installed visual of nearly uninterrupted surface continuity from panel to panel. • Recessed Reveals can be specified to run between panels in both vertical and horizontal orientations; the two orientations can run concurrently or separately. 	<ul style="list-style-type: none"> • Fin Reveals are flush with the panel face and available in Stainless Steel, Antique Bronze, or Matte Black. • Fin Reveals can be used to visually "frame" individual panels but aren't technically panel frames; the Fins attached to the subsystem and are separate from the panels. • Fin Reveals can be specified to run between panels in both vertical and horizontal orientations; the two orientations can run concurrently or separately. 	<ul style="list-style-type: none"> • LED Lit Reveals are available with 3200K or 5000K color temperatures (coordinating with the LED Cove Base and the Elevator Ceiling). • LED Lit Reveals can be specified to run between panels in a single orientation only: either vertically or horizontally, depending on panel configuration selected. • All lighting systems include a power supply, wire harnessing and an integrated LED dimmer. Lighting systems come pre-wired with a 12 foot lead to allow for mounting to top of cab shell. • A dedicated input circuit is required for Reveals that are specified with a lighting option. • LED lighting will stay illuminated if a single diode fails.

*When incorporating LED details, it's recommended that the LED color temperature be the same throughout the elevator interior (bases, reveals, and ceiling).



SYSTEM COMPONENTS (CONTINUED)

CORNER REVEALS	
<ul style="list-style-type: none"> • 90° angled Corner Reveals are supplied for the cab rear corners. • Front Corner Reveals are supplied for corners nearest the elevator door. • Corner Reveals are available in Clear or Black anodized finishes and field-installed with pre-applied mounting adhesive. 	 <p style="text-align: center;">CLEAR BLACK</p>

PERIMETERS FINIS	
<ul style="list-style-type: none"> • Perimeter Fins with pre-applied mounting adhesive are installed in the field. • Perimeter Fins are flush with the panel face and available in Stainless Steel, Antique Bronze, or Matte Black. 	 <p style="text-align: center;">STAINLESS STEEL ANTIQUE BRONZE MATTE BLACK</p>

BASES

Three styles of bases, all 3.5" (88.9 mm) high, are designed to fit between the finished floor and the wall panels. Each brings a different visual finish to the overall cab design. Bases consist of a decorative Architectural Metal face material applied to an extruded aluminum substrate with pre-applied mounting adhesive.

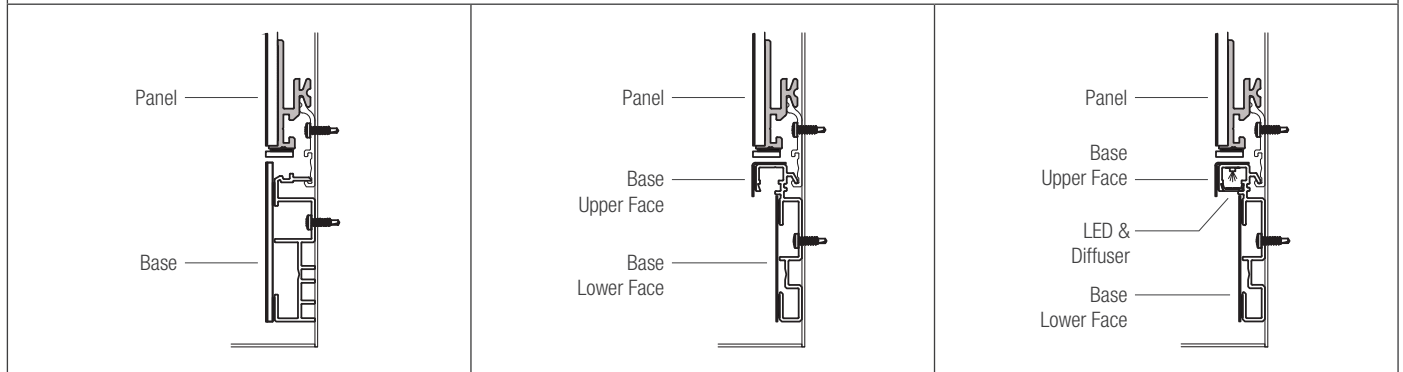

FLUSH BASE	COVE BASE	LED COVE BASE*
<ul style="list-style-type: none"> • Flush Bases incorporate one decorative face. 	<ul style="list-style-type: none"> • Cove Bases incorporate upper and lower decorative faces. 	<ul style="list-style-type: none"> • LED Cove Bases incorporate illumination and upper and lower decorative faces. • All lighting systems include a power supply, wire harnessing and an integrated LED dimmer. Lighting systems come pre-wired with a 12 foot lead to allow for mounting to top of cab shell. • A dedicated input circuit is required for Bases that are specified with a lighting option. • LED lighting will stay illuminated if a single diode fails.

*When incorporating LED details, it's recommended that the LED color temperature be the same throughout the elevator interior (bases, reveals, and ceiling).



HANDRAILS & CRASH RAILS

Handrails and crash rails can be specified for elevator interior back walls and/or side walls. For information on the full range of options, refer to the separate Elevator Handrails & Crash Rails Product Data Sheet.

In addition, LEVELr Elevator Interiors are available with a sleek Fin Mounted Handrail. Exclusive to LEVELr Elevator Interiors, Fin Mounted Handrails align with the refined aesthetics of other LEVELr components and can be used with or without handrail panels as described below.

<p>FIN MOUNTED HANDRAIL WITHOUT HANDRAIL PANEL</p> <ul style="list-style-type: none"> • Fin Mounted Handrails are designed for use without separate handrail panels. • Fin Mounted Handrails consist of a 2" x 1.5" rectangular cross-section rail, oriented with the narrow edge facing out, and a fin-mounted standoff. • Rails and standoffs are always the same material and finish and are available in Stainless Steel and Antique Bronze. 	<p>Diagram illustrating the installation of a Fin Mounted Handrail without a handrail panel. The components shown are the Wall Panel, Handrail Grip, Fin Mounted Standoff, and Wall Panel.</p>
<p>FIN MOUNTED HANDRAIL WITH HANDRAIL PANEL</p> <ul style="list-style-type: none"> • Fin Mounted Handrails can also be used with handrail panels. • Handrail panels 1.79" high consist of an Architectural Metal decorative face material bonded to a structural backer that's field-applied to an aluminum spacer and Stainless Steel support with pre-applied mounting adhesive. 	<p>Diagram illustrating the installation of a Fin Mounted Handrail with a handrail panel. The components shown are the Wall Panel, Handrail Panel, Handrail Grip, Fin Mounted Standoff, and Wall Panel.</p>



ELEVATOR CEILINGS

Our standard elevator ceiling is a six-panel suspended island design with six low-voltage, high-efficiency LED downlights or high-output LED perimeter lighting. In addition, LED downlights can be used in combination with either LED perimeter accent lighting or high-output LED perimeter lighting. Our elevator ceilings can support a maximum of nine downlights, depending on ceiling size. For more information, please see the Elevator Ceilings Product Data Sheet.

CEILING OPTIONS	CEILING INSTALLATION	LIGHTING
<ul style="list-style-type: none"> Our standard elevator ceiling panels consist of Stainless Steel or Fused Metal decorative faces applied to a structural backer with black reveals. Any of our standard Stainless Steel or Fused Metal finishes may be specified for panel faces. The ceiling mounting extrusion is extruded aluminum with a clear anodized finish. 	<ul style="list-style-type: none"> The ceiling uses a side-mount installation system that attaches the ceiling to the upper side walls of the elevator shell. This system makes the ceiling very easy to install and provides a generous range of adjustment to align the ceiling with the wall panels. A top-mount ceiling option that incorporates track-adjustable tie rods is available for large elevators and elevator configurations not conducive to the side-mount standard. A minimum clearance of 8" from the cab shell canopy to the visible ceiling face is necessary for installation. 	<ul style="list-style-type: none"> All lighting systems include a power supply, wire harnessing and an integrated LED dimmer. Lighting systems come pre-wired with a 12 foot lead to allow for mounting to top of cab shell. A dedicated input circuit is required for ceilings that are specified with a lighting option. LED Perimeter lighting will stay illuminated if a single diode fails.

ELEVATOR CEILING LIGHTING OPTIONS

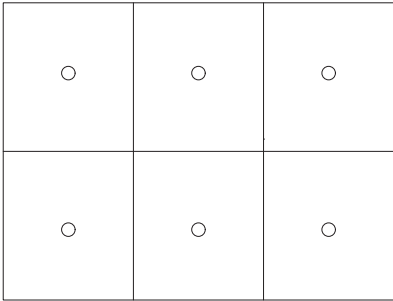
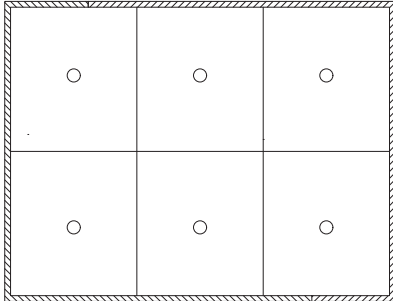
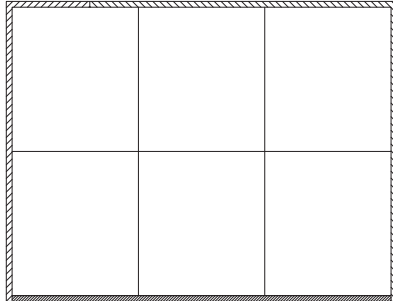
LED DOWNLIGHTS ONLY	LED DOWNLIGHTS + PERIMETER LIGHTING	LED PERIMETER LIGHTING ONLY
		
<ul style="list-style-type: none"> Low-voltage, high-efficiency LED downlights 	<ul style="list-style-type: none"> When used with LED downlights, either LED perimeter accent lighting or high-output LED perimeter lighting may be specified. 	<ul style="list-style-type: none"> High-output LED perimeter lighting

ELEVATOR CEILING ILLUMINATION*

Lighting Options	Light Reading in foot candles (fc)		
	At Threshold, on the ground	Center of Cab, on the ground	Center of Cab, 36" above floor
LED Downlights Only	29.8	45.5	62.5
LED Downlights + Perimeter Lighting	37.5	57.7	75.4
High-Output LED Perimeter Only	17.1	17.7	24.3

*Foot candle readings are dependent on finishes, colors, and/or reflectivity of the surfaces in the cab. The values shown are minimums.



EMERGENCY & VENTILATION

<p>EMERGENCY LIGHTING</p> <p>Emergency lighting is included in the standard elevator ceiling lighting system, unless otherwise specified in writing. The emergency lighting system incorporates an additional power supply with a battery to power the emergency lights in the event of a main power failure. The power supply includes an automatic battery charger, test switch, low battery voltage circuit, and alarm terminals. The emergency lights are integrated into the standard downlight system; any of the downlights, as specified, can act as the emergency light. In ceilings without downlights, a separate emergency lighting system will be located at the front of the cab, unless otherwise specified.</p>	<p>EMERGENCY EXIT</p> <p>The emergency exit can be placed anywhere in the ceiling as needed to line up with the exit opening in the cab shell canopy. The Design Guide asks you to detail the exact placement and this information will be verified via approval drawings.</p>
<p>VENTILATION</p> <p>Elevator Interiors are designed to accommodate most standard vent configurations. Unusual or non-standard ventilation requirements should be brought to our attention and detailed in the approval drawings to ensure compliance once material is installed.</p>	<p>FIRE RATINGS</p> <p>Ceiling panel backer materials and all Stainless Steel and Fused Metal are generally considered to be Class A/I fire-rated for smoke development and flame spread.</p>

DELIVERY & INSTALLATION

<p>DELIVERY</p> <p>Wall panels, bases, reveals, handrails and crash rails (if applicable) for each individual cab arrive in a single crate, unless glass panels are required. Glass or LightPlane Panels will be packaged separately in A-frame crates, making it easy to organize materials on site. Ceilings, if specified, are also crated separately. All crates arrive with components neatly organized and includes all the necessary fasteners, adhesives and installation instructions.</p>	<p>ELEVATOR INTERIOR INSTALLATION</p> <p>Designed to be quick and efficient, LEVELr installation starts with affixing the horizontal Base Cleat and then the vertical End Stops. These horizontal extrusions set the alignment for the wall panels. Wall Panels engage with the extrusions and are secured with Panel Clips that interlock with the Reveal components for fast and easy installation. Perimeter Fins and Base Facing are applied last for a polished look.</p>	<p>WALL PANEL REPLACEMENT</p> <p>If wall panels are ever damaged due to accident or vandalism, replacement panels can be ordered from Forms+Surfaces.</p>
------------------------------------------------------------------------------------------------------------------------------------------------------------------------------------------------------------------------------------------------------------------------------------------------------------------------------------------------------------------------------------------------------------------------------------------------------------------------------------------------------------	---------------------------------------------------------------------------------------------------------------------------------------------------------------------------------------------------------------------------------------------------------------------------------------------------------------------------------------------------------------------------------------------------------------------------------------------------------------------------------------	------------------------------------------------------------------------------------------------------------------------------------------------------------------

CODE COMPLIANCES

Elevator wall panels, bases, handrails, crash rails, and ceilings comply with the following codes and guidelines:

<p>ASME A17.1-2010: Safety Code for Car Enclosures, Car Doors and Gates, and Car Illumination - Section 2.14</p>
<ul style="list-style-type: none"> • 2.14.1.2 - Securing of Enclosures • 2.14.1.5 - Top Emergency Exits • 2.14.1.8 - Glass in Elevator Cars • 2.14.2.1 - Material for Car Enclosures, Enclosure Linings, and Floor Coverings • 2.14.2.3 - Ventilation • 2.14.2.4 - Headroom in Elevator Cars • 2.14.7.4 - Protection of Light Bulbs and Tubes
<p>2001 California Building Code, Chapter 30</p>
<ul style="list-style-type: none"> • 3003.4.7 - Car Inside* • 3003.4.12 - Handrails
<p>Americans with Disabilities Act Accessibility Guidelines (ADAAG)</p>
<ul style="list-style-type: none"> • 4.10.9 - Floor Plan of Elevator Cars*

*Complies when installed in most common sizes of passenger cabs and service cabs. Purchasing party is responsible for ensuring that finished installation maintains minimum floor dimensions required by ADA guidelines and applicable local codes.



RELATED PRODUCTS

LEVELr WALL CLADDING SYSTEM	LEVELr COLUMN SYSTEM	ELEVATOR DOOR SKINS
The LEVELr Wall Cladding System incorporates the same panel types and materials and finishes as those offered for LEVELr Elevator Interiors. Please refer to the LEVELr Wall Cladding System Product Data Sheet for additional information.	The LEVELr Column System incorporates the same panel types and materials and finishes as those offered for LEVELr Elevator Interiors. Please refer to the LEVELr Column System Product Data Sheet for additional information.	Forms+Surfaces Elevator Door Skins are available in many of the same materials and finishes as those offered for LEVELr Walls, Columns, and Elevator Interiors. Please refer to our Elevator Doors Product Data Sheets for additional information.
LEVELe ELEVATOR INTERIORS	LEVELc ELEVATOR INTERIORS	ARCHITECTURAL ACCENTS
LEVELe Elevator Interiors represent a versatile panelized system based on lightweight aluminum framed panels and extensive material options. Please refer to the LEVELe Elevator Interiors Product Data Sheet for additional information.	LEVELc Elevator Interiors expand the design and performance options with many of the same materials and finishes offered for LEVELr Elevator Interiors. Please refer to our LEVELc Elevator Interiors Product Data Sheet for additional information.	Coordinating sheet goods are available for headers, jams, returns, transoms and other architectural features. Please refer to our assortment of Surfaces Product Data Sheets for additional information.

CUSTOM ELEVATOR INTERIORS

If your design requirements go beyond the standard LEVELr configuration, material and finish offerings, customized versions are available for an additional charge. Please call us to discuss your needs.

LEAD TIME

Standard lead times are approximately 6-8 weeks, however, lead times can vary depending on the specifics of the products involved, the scope of supply and scheduling capacity at time of order approval. Please contact us to discuss your specific timing requirements.

TECHNICAL SUPPORT & PROJECT MANAGEMENT

Because each project is unique, our knowledgeable support team is ready to help. Our technical sales, engineering, sustainability, and project management professionals regularly assist our clients worldwide. Please contact us at 800.451.0410 or sales@forms-surfaces.com to discuss your project.

HOW TO SPECIFY

Visit www.elevatordesignstudio.com to configure your elevator interior using the Elevator Design Studio, our interactive online design tool that puts creative control at your fingertips. The intuitive step-by-step format lets you choose an elevator interior configuration, apply materials and finishes from our extensive Surfaces library, view your progress in realistic renderings, and request budget pricing - all with a few simple clicks.