

RINCON™ BOLLARD

SURFACE MOUNT INSTALLATION INSTRUCTIONS

MOUNTING KIT (SOLD SEPARATELY)

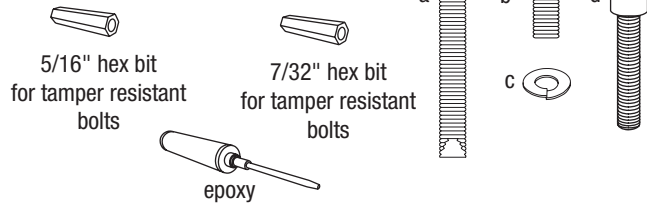

TOOLS NEEDED

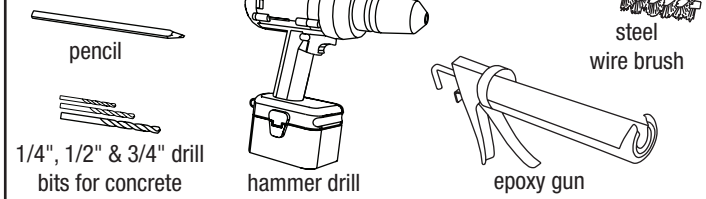

STEP BY STEP FOR ALL RINCON BOLLARDS

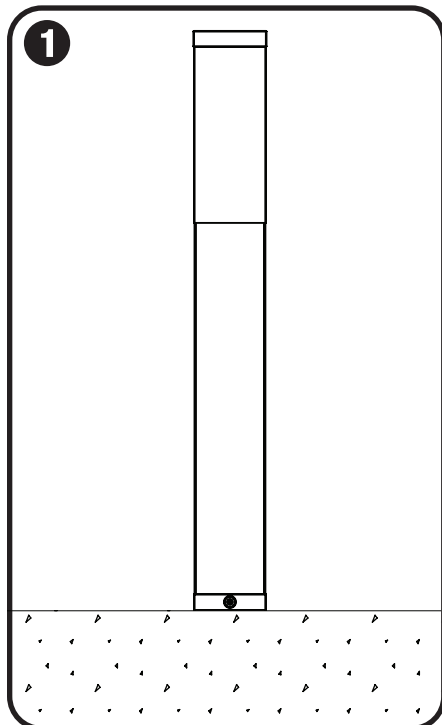

Mark hole locations

- Place the bollard in desired location. Mark center of each hole location (four total) with a pencil. Mounting holes are located on the bollard's base.

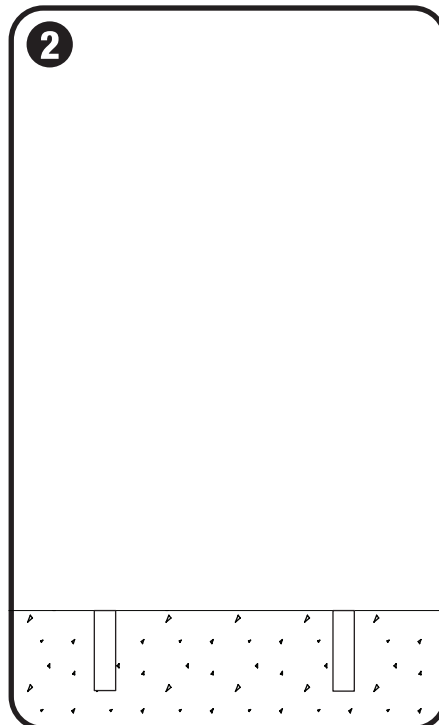

Drill holes

- Use hammer drill to drill 4.5" deep x 3/4" diameter anchor holes at each marked location using a 3/4" drill bit suitable for concrete drilling.

NOTE: Forms+Surfaces recommends starting holes with 1/4" diameter drill bit followed by 1/2" and finally 3/4" for maximum accuracy.

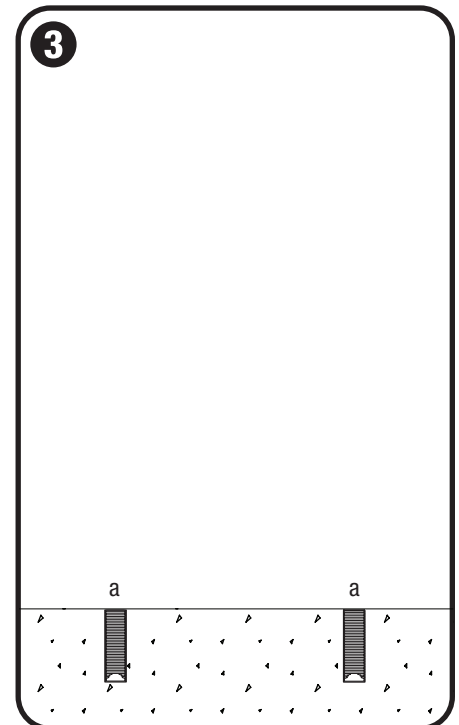

Fill holes & insert anchors

- Use compressed air and steel wire brush to clean each anchor hole in accordance with epoxy instructions.
- Use epoxy in epoxy gun to fill each anchor hole 5/8" of the hole depth in accordance with epoxy instructions.
- Insert 3/8"-13 x 4-1/4" epoxy anchor (a) into each anchor hole so anchor top is flush with ground. Allow proper curing time according to cure schedule on epoxy instructions before moving on to Step 5.

RINCON™ BOLLARD

SURFACE MOUNT INSTALLATION INSTRUCTIONS

STEP BY STEP FOR ALL RINCON BOLLARDS

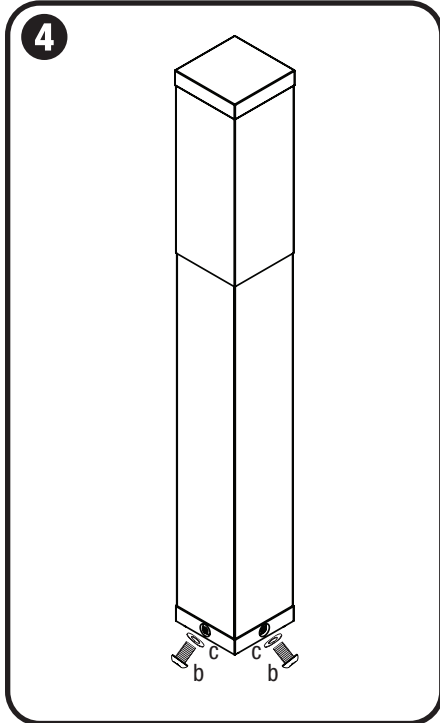

Remove side bolts from base

- Remove 3/8"-16 x 3/4" tamper-resistant button head cap bolt (b) and lock washer (c) from all four sides of base, allowing the base to be separated from the bollard.

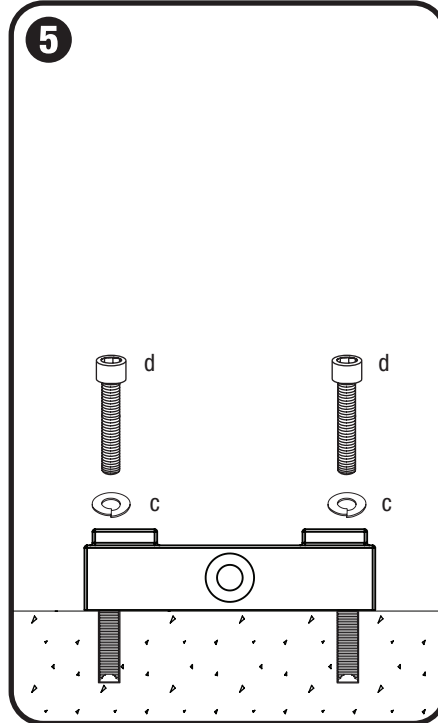

Position base and bolt to ground

- Position base so that mounting holes line up with anchors.
- Slide 3/8" stainless steel lock washer (c) onto each 3/8"-16 x 3" socket head cap bolt (d), and thread into anchors using 5/16" hex bit for tamper-resistant bolts.

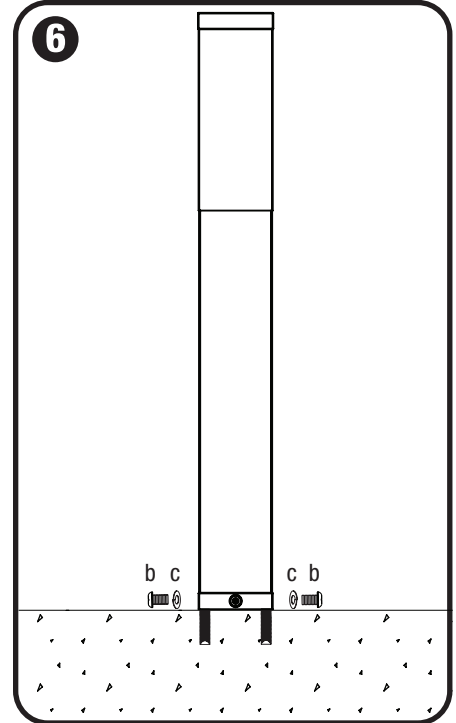

Attach bollard to base and tighten bolts

- Place bollard onto base. Slide 3/8" stainless steel lock washer (c) onto each 3/8"-16 x 3/4" tamper-resistant button head cap bolt (b). Thread into bolt holes on all four sides of base using 7/32" hex bit for tamper-resistant bolts.
- Tighten bolts until snug.