

CORDIA™ BOLLARD

SURFACE MOUNT INSTALLATION INSTRUCTIONS

MOUNTING KIT (SOLD SEPARATELY)

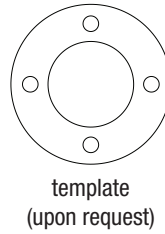
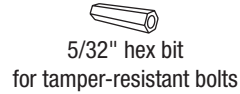
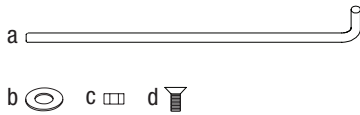

TOOLS NEEDED

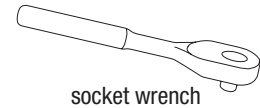

STEP BY STEP FOR ALL CORDIA BOLLARDS

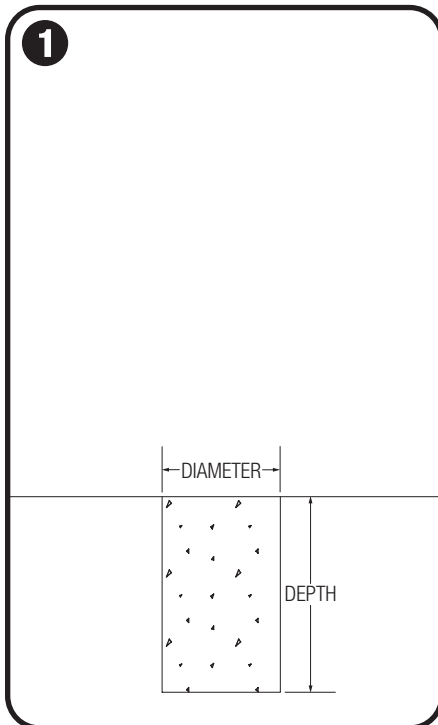

Pour concrete footer

- Mix and pour concrete footer according to concrete manufacturer's instructions.
- A sufficient footer size depends on frost and other conditions to be determined by the installer. A minimum of a 13" diameter x 20" deep footer is recommended.

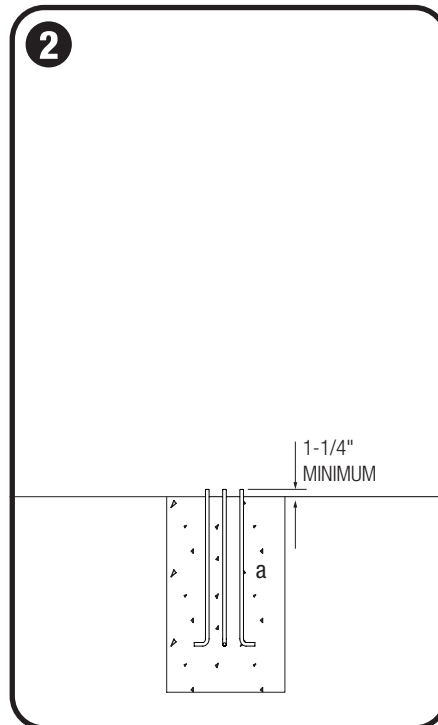

Insert J-bolt anchors

- Insert 1/2"-13 x 18" galvanized steel J-bolt anchors (a) into concrete.
- Use template to position J-bolt anchors in proper locations. Tops of J-bolt anchors must be a minimum of 1-1/4" above concrete surface.
- Allow concrete to set completely, in accordance with concrete manufacturer's instructions, before moving to step 3.

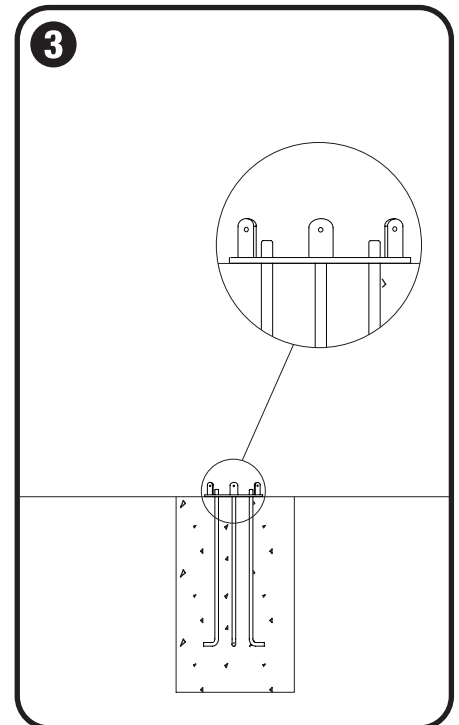

Slide base plate onto J-bolt anchors

- Slide base plate over J-bolt anchors and lower to concrete level.

CORDIA™ BOLLARD

SURFACE MOUNT INSTALLATION INSTRUCTIONS

STEP BY STEP FOR ALL CORDIA BOLLARDS

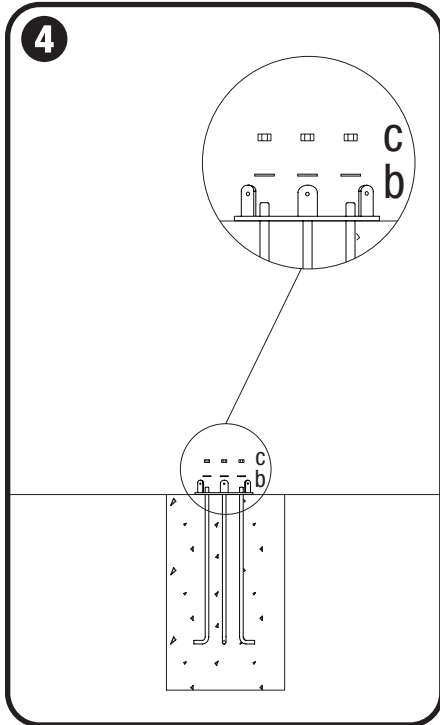

Attach base plate & tighten

- Slide 1/2" washer (b), then thread 1/2"-13 nut (c) onto each J-bolt anchor.
- Use socket wrench and 3/4" socket to tighten all nuts until snug.

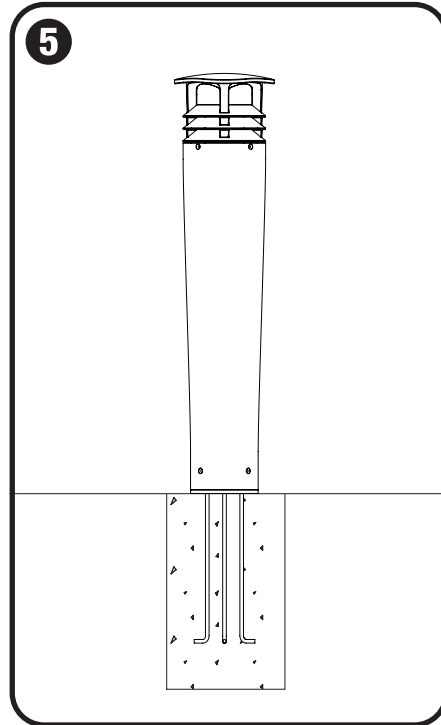

Slide bollard onto base plate

- Slide bollard over base plate and lower.

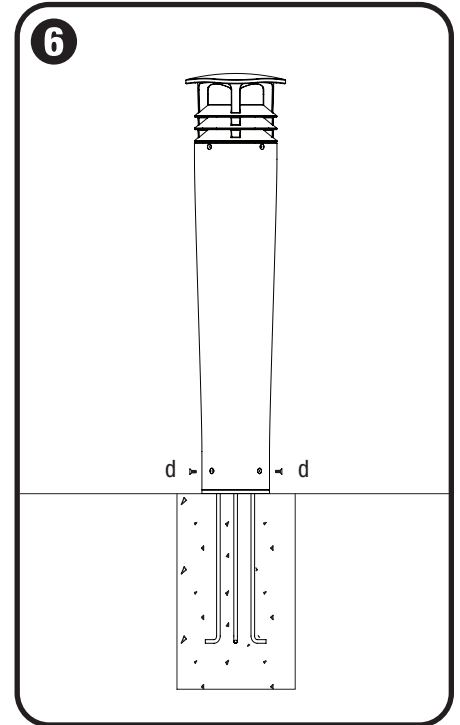

Attach bollard to base plate

- Thread 1/4"-20 x 3/4" tamper-resistant flat head cap bolt (d) into each hole.
- Use 5/32" hex bit for tamper-resistant bolts to tighten all bolts until snug.