

Elevators

ELEVATOR INTERIORS | ELEVATOR DOORS

FORMS+SURFACES®



CONTENTS

ELEVATOR INTERIORS	2
LEVELe Elevator Interiors	4
LEVELc Elevator Interiors	22
Elevator Ceilings	28
Elevator Handrails.....	30
Applications	32
LIGHTPLANE PANELS	36
ELEVATOR DOORS	40
Stainless Steel & Fused Metal	42
Bonded Metal.....	44
Applications	46
SURFACES	48
VividGlass	52
BermanGlass	54
Stainless Steel	56
Fused Metal.....	58
Linq Woven Metal.....	60
Bonded Metal	62
Bonded Quartz.....	64
Wood Veneer.....	66
DESIGN TOOLS	68
Elevator Design Studio	70
ViviStone Virtual Quarry	72
Zoom Digital Darkroom.....	74
VEKTR Digital Canvas.....	76

COMPREHENSIVE SUPPORT	78
ADDITIONAL RESOURCES	79

©2018 Forms+Surfaces. All dimensions are nominal. Specifications subject to change without notice.





LEVELe-105 Elevator Interior: Capture panels in Vivigraphix Graphica glass, customized Silksworm interlayer in White, Standard finish, and Bonded Bronze, Dark Panna, Rain pattern. Compass handrail. Fused Metal Elevator Doors in Fused Nickel Bronze, Satin finish, Seagrass Eco-Etch pattern. Grand Hyatt Washington, Washington, D.C.



elevator interiors

Ideal for new or modernization projects, our elevator interior systems give you a vast array of options for meeting diverse aesthetic, performance, environmental, and budgetary requirements. Featuring versatile wall panel layouts that can be configured in numerous ways, complete packages draw on our full Surfaces line-up and suit all typical cab sizes and door configurations.





LEVELe ELEVATOR INTERIORS



LEVELe-107 Elevator Interior: LightPlane Panels in ViviSpectra Spectrum glass, custom image interlayer, Pearlex finish; Capture panels in Stainless Steel, Sandstone finish; Fused Graphite, Linen finish; and custom plastic laminate. Round handrail. Chicago Board of Trade, Chicago, Illinois.

LEVELe Elevator Interiors bring the benefits of the LEVELe program to the elevator interior.

As with LEVELe Wall Cladding, this versatile panelized system is based on self-revealing extrusion channels, aluminum-framed panels with a lightweight structural backing, and extensive material options.

Eight configurations defined by wall panel shape and layout invite you to select materials and finishes from the F+S Surfaces palette. VividGlass, BermanGlass Levels Kiln Cast Glass, and LightPlane Panels are just some of the many options that can be used to create distinctive elevator interiors.

Standard LEVELe packages include wall panels, bases, reveals and installation hardware. Ceilings with or without lighting and handrails are optional.

LEVELe Elevator Interiors are designed to be easy to install, easy to maintain, easy to specify, and 25-50% lighter than typical elevator interiors.

LEVELe Elevator Interiors can be configured using our Elevator Design Studio. Learn more on page 70.





U.S. Mail
CARD READER
→

LETTERS
U.S. MAIL
LETTER BOX

STAIR & EXIT

CARD READER



LEVELe-101

Each wall of the LEVELe-101 is comprised of four vertical panels in varying widths. Two frame extrusion designs – Minimal and Capture – allow for a variety of materials and thicknesses, including glass.

F+S recommendation: use a maximum of three materials for the walls – one for each panel type (A, B & C). Handrail panel and base materials, as well as extrusion and corner reveal colors, can also be specified.

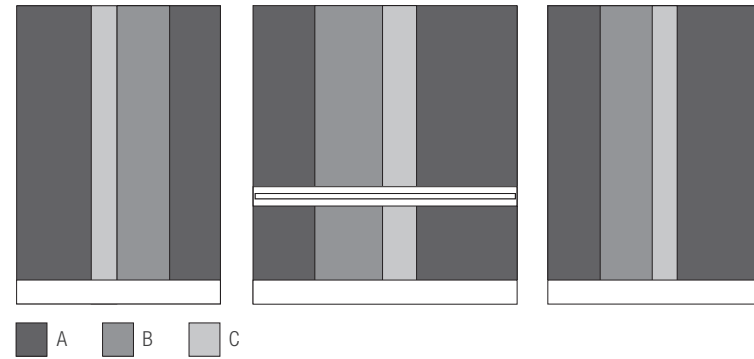
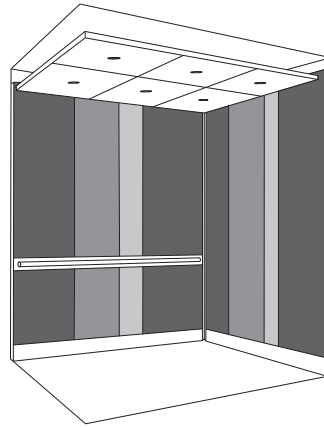

left to right: Customized layout of Capture panels in ViviChrome Chromis glass, White interlayer, Opalex finish; Fused Graphite, Linen finish; Stainless Steel, Satin finish; and custom wood veneer | Capture panels in Stainless Steel, Seastone finish; Stainless Steel, Seastone finish, Dallas Impression pattern; ViviChrome Chromis glass, Mirror Mist interlayer, Opalex finish | Capture panels in Bonded Bronze, Natural Patina, Grass pattern; Stainless Steel, Linen finish; and ViviChrome Chromis glass, custom color interlayer, Pearlex finish

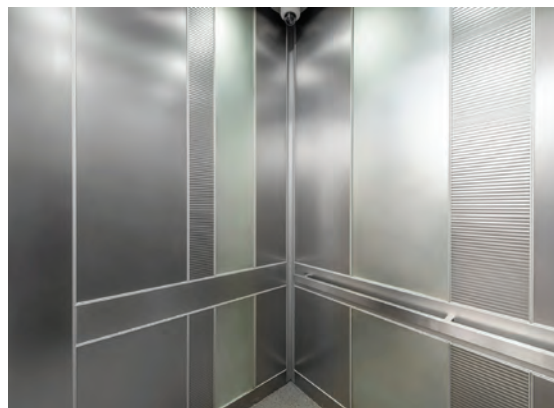

LEVELe-101 Elevator Interior: Minimal panels in Stainless Steel, Seastone finish; Fused White Gold, Seastone finish; and custom inset material. 520 & 1528 Woodward Avenue, Detroit, Michigan.



LEVELe-102

Each wall of the LEVELe-102 has horizontal panels bordered by vertical panels on both sides. Two frame extrusion designs – Minimal and Capture – allow for a variety of materials and thicknesses, including glass.

F+S recommendation: use a maximum of two materials for the walls – one for each panel type (A & B). Handrail panel and base materials, as well as extrusion and corner reveal colors, can also be specified.

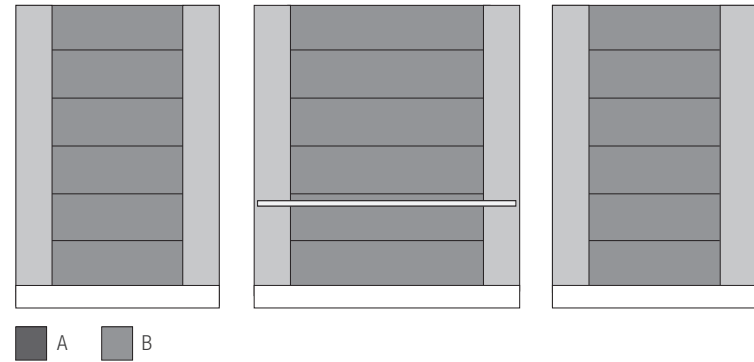
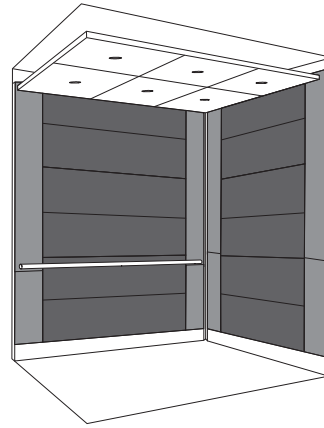

left to right: Capture panels in Bonded Aluminum, Dark Patina, Charleston pattern; and American Walnut wood veneer | Customized layout of Capture panels in Stainless Steel, Sandstone finish; Bonded Aluminum, Dark Patina, Charleston pattern; and Stainless Steel, Satin finish | Customized layout of Capture panels in Bonded Aluminum, Natural Patina, Grass pattern; Fused White Gold, Sandstone finish; and ViviChrome Chromis glass, White interlayer, Opalex finish









LEVELe-103

Each wall of the LEVELe-103 is comprised of horizontal panels with a vertical group of accent panels. The left wall's accent panels are at the front of the cab; the right wall's accent panels are at the back. Two frame extrusion designs – Minimal and Capture – allow for a variety of materials and thicknesses, including glass.

F+S recommendation: use a maximum of two materials for the walls – one for each panel type (A & B). Base materials, and extrusion and corner reveal colors, can also be specified.

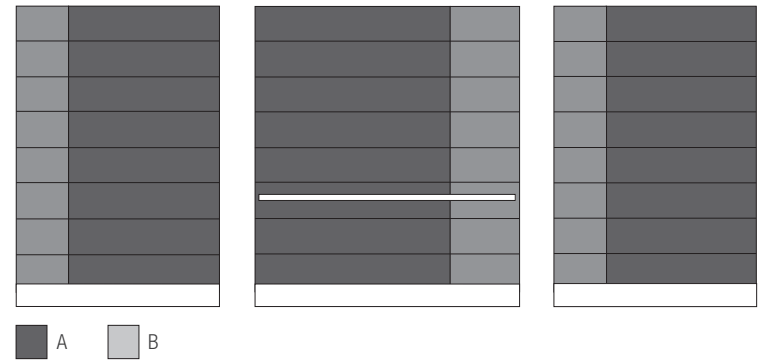
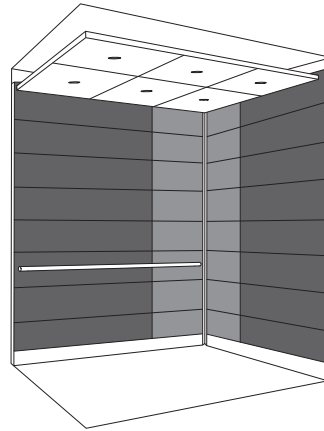

left to right: Capture panels in Stainless Steel, Seastone finish; and Bonded Quartz, White, Kalahari pattern | Minimal panels in custom wood veneer; and Bonded Bronze, Natural Patina, Waterfall pattern | Capture panels in ViviGraphix Graphica glass, Cairo interlayer in White, Standard finish; and Stainless Steel, Seastone finish, Seagrass Eco-Etch pattern





LEVELe-104

Each wall of the LEVELe-104 is comprised of horizontal panels. Two frame extrusion designs – Minimal and Capture – allow for a variety of materials and thicknesses, including glass.

F+S recommendation: use a maximum of three materials for the walls – one for each panel type (A, B & C). Handrail panel and base materials, as well as extrusion and corner reveal colors, can also be specified.

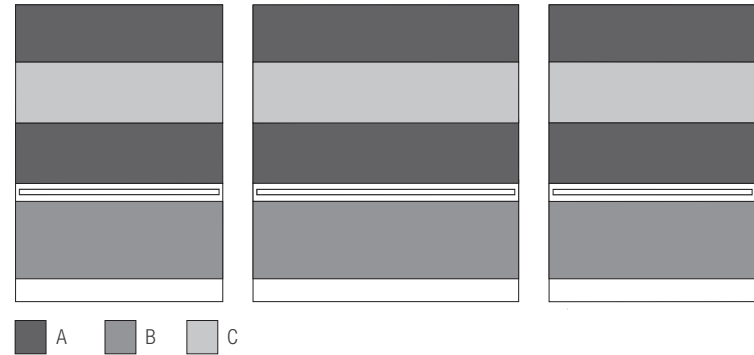
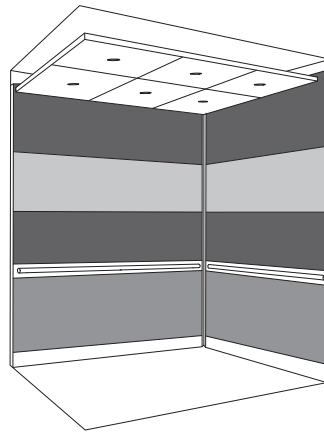

left to right: Minimal panels in Stainless Steel, Sandstone finish; and Fused Graphite, Mirror finish, custom Eco-Etch pattern | Capture panels in ViviSpectra Elements glass, White Marble interlayer, Pearlex finish; ViviSpectra Spectrum glass, custom image interlayer, Pearlex finish; and Linq Woven Metal, Sum Crosslinq pattern in Stainless Steel | Minimal panels in Bonded Aluminum, Dark Patina, Grass pattern; and Stainless Steel, Sandstone finish



LEVELe-104 Elevator Interior: Capture panels in ViviChrome Chromis glass, White interlayer, Opalex finish; and Bonded Aluminum, Dark patina, Austin pattern. Round handrails. Northwestern Memorial Hospital Outpatient Care Pavilion - Parking Garage, Chicago, Illinois.



2

4

4

2
A2

2
A2

3
A2





11

11





LEVELe-105

The back wall of the LEVELe-105 is comprised of six panels; side walls are comprised of four. Two frame extrusion designs – Minimal and Capture – allow for a variety of materials and thicknesses, including glass.

F+S recommendation: for the wall panels (A, B, C, & D), combine a maximum of two materials in a variety of layouts. Handrail panel and base materials, and extrusion and corner reveal colors, can also be specified.

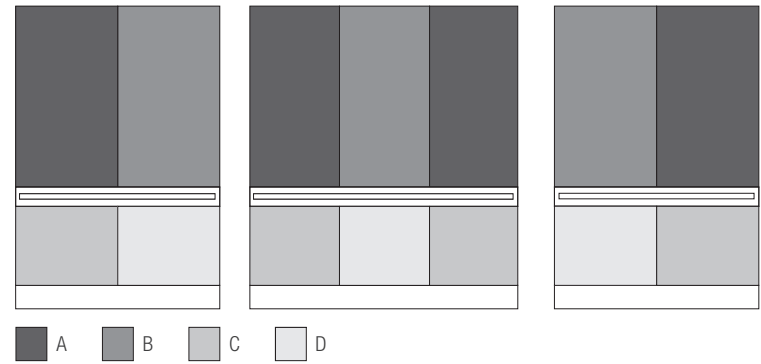
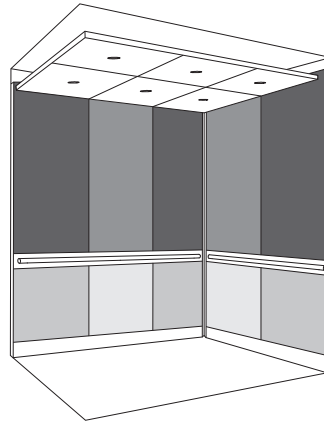

left to right: Capture panels in ViviStone Honey Onyx glass with customized interlayer; custom Linq Woven Metal; and Fused Bronze, Satin finish | Capture panels in ViviGraphix Graphica glass, custom graphic interlayer; Bonded Aluminum, Dark Patina, Grass pattern; and Stainless Steel, Seastone finish | Capture panels in ViviGraphix Graphica glass, customized Silkworm interlayer in White, Standard finish; and Bonded Bronze, Dark Patina, Rain pattern





LEVELe-106

Each wall of the LEVELe-106 consists of six panels of varied sizes. Two frame extrusion designs – Minimal and Capture – allow for a variety of materials and thicknesses, including glass.

F+S recommendation: use a maximum of three materials for the walls – one for each panel type (A, B & C). Base material, as well as extrusion and corner reveal colors, can also be specified.

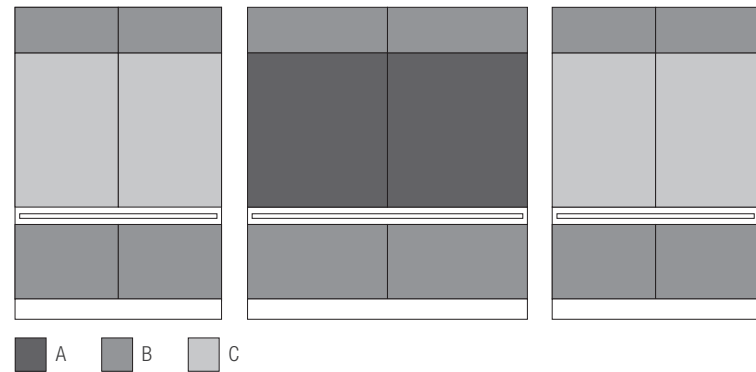
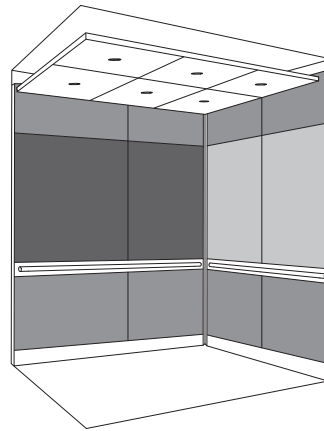

left to right: Capture panels in Bonded Quartz, White, Carbon pattern; and Stainless Steel, Seastone finish | Capture panels in custom wood veneer; ViviChrome Chromis glass, custom color interlayer, Standard finish; and Fused Bronze, Satin finish | Capture panels in ViviStone Cream Onyx glass, Pearlex finish; Bonded Bronze, Dark patina, Charleston pattern; and Stainless Steel, Sandstone finish



LEVELe-106 Elevator Interior: LightPlane Panels in ViviStone Pearl Onyx glass, Pearlex finish; Capture panels in ViviChrome Chromis glass, Slate Blue interlayer, Pearlex finish; and Stainless Steel, Seastone finish. Quadrant handrails. 1100 Louisiana Street, Houston, Texas.



43







LEVELe-107

The back wall of the LEVELe-107 features a series of horizontal panels and a central vertical accent panel. Side walls have horizontal panels bordered by a vertical accent panel at the front of the cab. Two frame extrusion designs – Minimal and Capture – allow for a variety of materials and thicknesses, including glass.

F+S recommendation: use a maximum of three materials for the walls – one for each panel type (A, B & C). Base material, and extrusion and corner reveal colors, can also be specified.

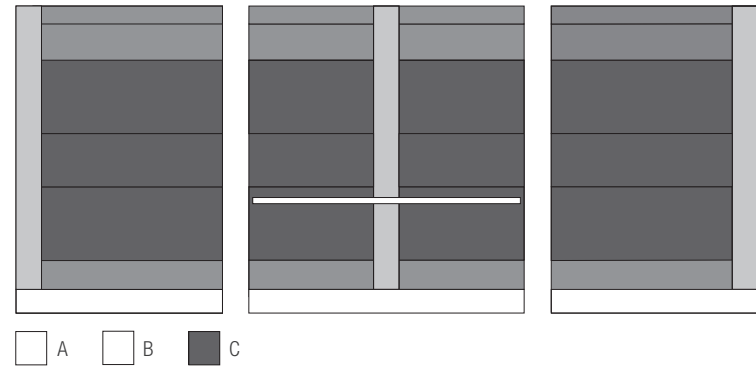
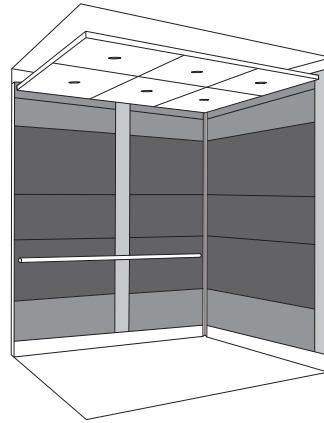

left to right: Capture panels in Bonded Nickel Silver, Dark Patina, Vancouver pattern; Stainless Steel, custom finish; and ViviChrome Chromis glass, Taupe interlayer, Opalex finish | Capture panels in Wenge wood veneer; Stainless Steel, Linen finish; and LightPlane Panel in ViviSpectra Elements glass, Yucca interlayer, Pearlex finish | Capture panels in ViviChrome Chromis glass, White interlayer, Opalex finish; Stainless Steel, Seastone finish; and LightPlane Panel in ViviGraphix Graphica glass, Silkworm interlayer, Pearlex finish





LEVELe-108

Each wall of the LEVELe-108 is comprised of upper and lower panels in a stepped gradation of sizes. Two frame extrusion designs – Minimal and Capture – allow for a variety of materials and thicknesses, including glass.

F+S recommendation: use a maximum of two materials for the walls – one for each panel type (A & B). Base materials, as well as extrusion and corner reveal colors, can also be specified.

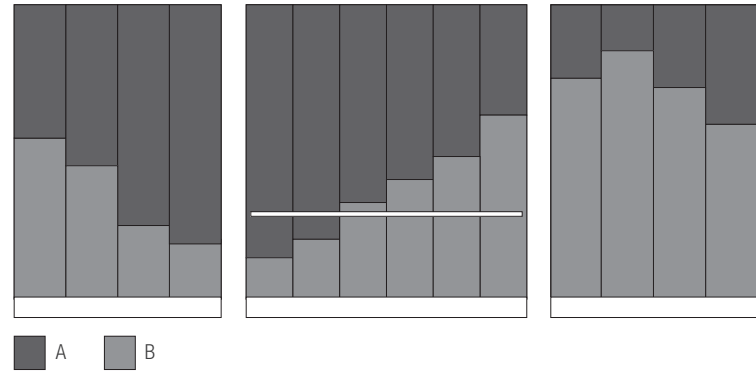
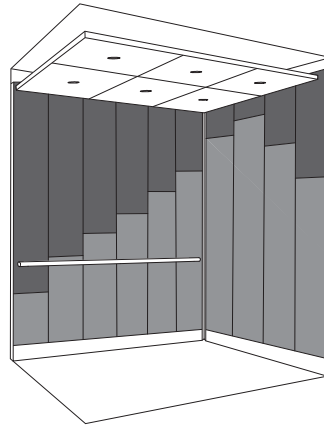

left to right: Capture panels in Stainless Steel, Mirror finish, City Lights Eco-Etch pattern; and Stainless Steel, Seastone finish | Customized layout of Minimal panels in Stainless Steel, Satin finish; Stainless Steel, Seastone finish; and Fused Graphite, Satin finish | Capture panels in ViviSpectra Spectrum glass, Skylight interlayer, Standard finish; and Stainless Steel, Seastone finish



LEVELe-108 Elevator Interior: Capture panels in Stainless Steel, Mirror finish, City Lights Eco-Etch pattern; and Stainless Steel, Seastone finish. Rectangular handrails. Representative location.







LEVELc ELEVATOR INTERIORS

LEVELc Elevator Interiors expand the design and performance options with layouts that can be tailored to different material themes and architectural styles.

LEVELc-1000A is a rugged full-panel stainless steel system optimized for airports, parking structures and other public spaces where durability and potential abuse are concerns.

LEVELc-2000N features a configurable stile, rail and inset design that accommodates a wide range of material and finish combinations. Options draw from our extensive Surfaces line-up and include VividGlass.

All standard LEVELc packages include wall panels, trim pieces and installation hardware. Ceilings with or without lighting and handrails are optional.

LEVELc Elevator Interiors can be configured using our Elevator Design Studio. Learn more about this interactive design tool on page 70.



LEVELc-2000N Elevator Interior: Insets in Bonded Aluminum; Charleston pattern, Natural Patina; and American Walnut wood veneer. Stiles and rails in Stainless Steel, Sandstone finish. Round handrails. IU Health Neuroscience Center, Indianapolis, Indiana.



LEVELc-1000A

LEVELc-1000A wall panels consist of a decorative metal face bonded to a fire-rated structural substrate. The metal face is a single sheet of stainless steel or Fused Metal.

F+S note: back and side walls can have matching stainless steel or Fused Metal panels or optional patterns can be used to vary the look of one of more of the walls.

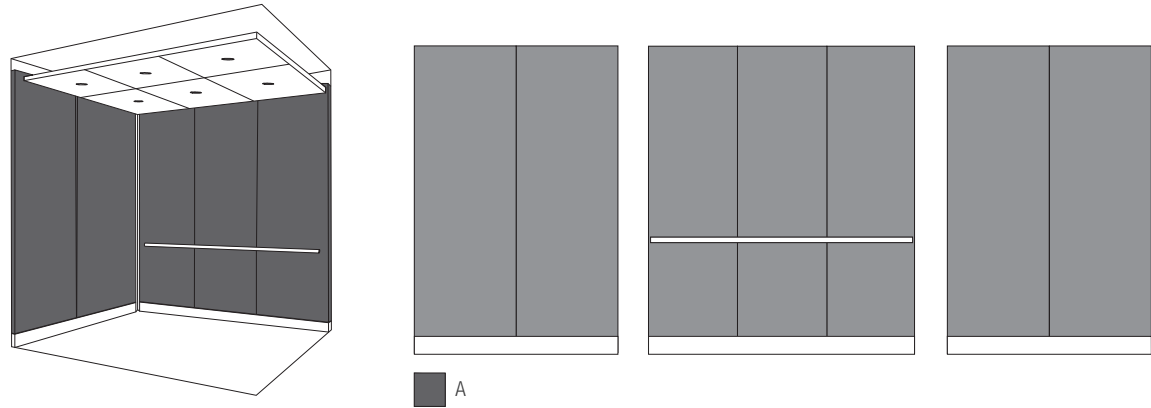

left to right: panels in Stainless Steel, Seastone finish | panels in Stainless Steel, Seastone finish | panels in Fused Nickel Silver, Linen finish

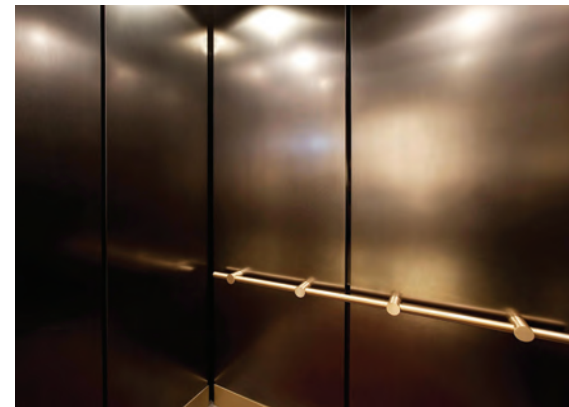





2

EMERGENCY EVACUATION
INSTRUCTIONS



2

EXIT



Pha



LEVELc-2000N

Each wall of the LEVELc-2000N is comprised of panels featuring a stile, rail and inset design. Panel elements in a variety of materials and finishes, including glass, may be selected to coordinate or contrast with one another.

F+S recommendation: use a maximum of two materials for the wall panel insets – one for the upper insets (A) and one for the lower insets (B). Stiles and rails (C) can be specified in complementary stainless steel and Fused Metal finishes.

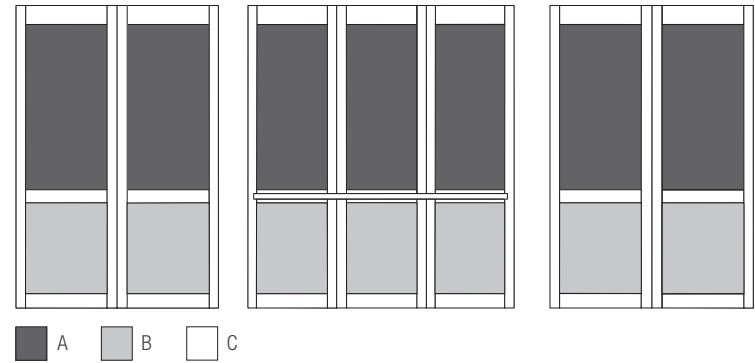
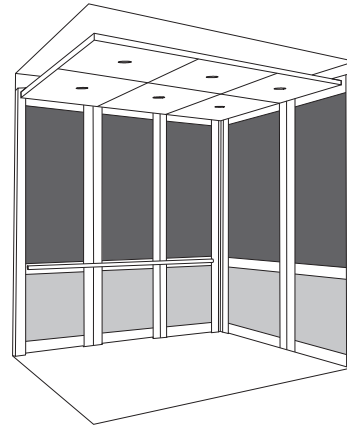

left to right: Insets in Bamboo wood veneer; and Bonded Bronze, Chardonnay pattern, Natural Patina; stiles and rails in Stainless Steel, Sandstone finish | Insets in Stainless Steel, Seastone finish, Carbon Fusion pattern; stiles and rails in Stainless Steel, Satin finish | Insets in American Cherry wood veneer; Stainless Steel, Seastone finish, Cinch Fusion pattern; and stiles and rails in Stainless Steel, Sandstone finish



LEVELc-2000N Elevator Interiors: insets in Vivigraphix Graphica glass, Seagrass interlayer in White, Standard finish; and Stainless Steel, custom finish; stiles and rails in Stainless Steel, Sandstone finish. Quadrant handrails. Walgreens Corporate Headquarters, Deerfield, Illinois.



ELEVATOR CEILING

Based on a framework of interlocking extrusions, our Elevator Ceilings are lightweight, easy to install and include many of the same stainless steel and Fused Metal options as our Elevator Interiors. The standard ceiling is a six-panel suspended island design with six low-voltage high-efficiency LED downlights and/or LED perimeter lighting.

Ceilings use a side-mount installation system that provides a generous range of adjustment to align the ceiling with the wall panels. Standard packages include ceiling with light fixture and emergency lighting power source.

Elevator Ceilings can be specified with LEVELe or LEVELc Elevator Interiors or incorporated into existing or custom elevator interiors.

left to right/top to bottom: ceiling in Fused White Gold, Mirror finish, with LED downlights and LED perimeter accent lighting | ceiling in Stainless Steel, Seastone finish, with LED downlights and LED perimeter accent lighting | ceiling in Stainless Steel, Sandstone finish, with LED perimeter lighting | ceiling in Stainless Steel, Satin finish, with LED downlights | ceiling in Stainless Steel, Seastone finish, with LED downlights



Elevator ceiling in Stainless Steel, Seastone finish, with LED perimeter lighting, Private Location, New York, New York.







ELEVATOR HANDRAILS

Elevator Handrails are optional and can be specified for elevator back walls and/or side walls. While designed specifically for LEVELe and LEVELc Elevator Interiors, they can be used in other elevator interiors as well.

Six different series provide a range of stylistic possibilities. Material options include stainless steel and bronze, each in a variety of finishes selected to complement other materials featured in the elevator interior.

For continuity throughout a space, our Elevator Handrails have been designed to coordinate with our Door Pull designs.

left to right/top to bottom: Round handrail in Satin Bronze | Modular handrail in Satin Stainless Steel with clear anodized aluminum standoff | Compass handrail in Satin Stainless Steel with Ring standoff | Quadrant handrail in Satin Stainless Steel with Vise standoff in Polished Stainless Steel | Compass handrail in Satin Stainless Steel with Cylinder standoff

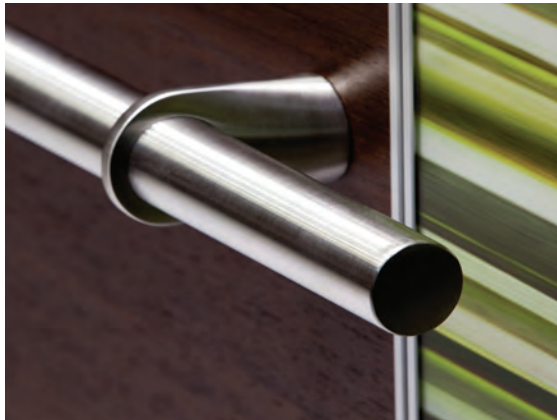



ELEVATOR INTERIOR APPLICATIONS



LEVELe-107 Elevator Interior: LightPlane panels in ViviSpectra Spectrum glass, custom image interlayer, Pearlex finish; Capture panels in Stainless Steel, Sandstone finish; Fused Graphite, Linen finish; and custom plastic laminate. Chicago Board of Trade, Chicago, Illinois. | LEVELe-102 Elevator Interior: Capture panels in ViviGraphix Graphica glass, Cairo interlayer in White, Standard finish; ViviChrome Chromis glass, White interlayer, Opalex finish; and American Cherry with Dark Mahogany Stain wood veneer. Round handrail. Sallie Mae, Newark, Delaware.



LEVELe-104 Elevator Interior: customized layout of Capture panels in ViviChrome Chromis glass, White interlayer, Opalex finish; and Bonded Aluminum, Natural Patina, Grass pattern. Mercy Health – West Hospital, Cincinnati, Ohio. | LEVELe-103 Elevator Interior: Minimal panels in Fused White Gold, Sandstone finish; and custom laminate. Edward Hines, Jr. VA Hospital, Hines, Illinois.



ELEVATOR INTERIOR APPLICATIONS



LEVELe Wall Cladding System: Blind panels in ViviChrome Chromis glass, custom color interlayer, Opalex finish. LEVELe-105 Elevator Interior: Capture panels in ViviChrome Chromis glass, custom color interlayer, Opalex finish; Fused Graphite, Sandstone finish; and Stainless Steel, Satin finish. Rectangular handrail. Mission City Corporate Center, San Diego, California. | LEVELe-105 Elevator Interior: Customized Minimal panel layout in Bonded Bronze, Natural Patina, Dash pattern; and Fused Nickel Silver, Seastone finish. Round handrail. Akshaya Signature Homes, Chennai, India.



LEVELe-101 Elevator Interior: Capture panels in Bonded Bronze, Natural Patina, Grass pattern; Stainless Steel, Linen finish; and ViviChrome Chromis glass, custom color interlayer, Pearlex finish. Rectangular handrails and custom bumper rails. Renaissance Towers, San Diego, California. | LEVELc-2000N Elevator Interior: Insets in Bonded Aluminum, Natural Patina, Charleston pattern; and American Walnut wood veneer; stiles and rails in Stainless Steel, Sandstone finish. Round handrails. IU Health Neuroscience Center, Indianapolis, Indiana.



EXIT



lightplane panels

LightPlane Panels are engineered, edge-lit LED panels that allow seamless illumination of walls, columns, elevator interiors, and standalone panels and displays. LightPlane Panels combine our cutting-edge lighting technology, our VividGlass and BermanGlass Levels architectural glass, and a highly engineered framing system to create an illuminated panel unlike any other.



LightPlane Panels in VividChrome Chromis glass, Seaglass interlayer, Pearlex finish. Private Location, Short Hills, New Jersey.



A

1-14

1-14

RESEARCH TECHNOLOGIES

1950s

A
1

EXIT



LIGHTPLANE PANELS

LightPlane Panels are available as a standard option in our LEVELe Elevator Interiors. For easy coordination with other materials used within the cab, LightPlane Panels have the same visible profile as LEVELe Capture panels.

LightPlane Panels are available with VividGlass in a vast array of standard and custom designs, and with BermanGlass Levels Kiln Cast Glass. Panel frames are extruded aluminum in Clear, Black, Antique Bronze or Duranodic Bronze anodized finishes.

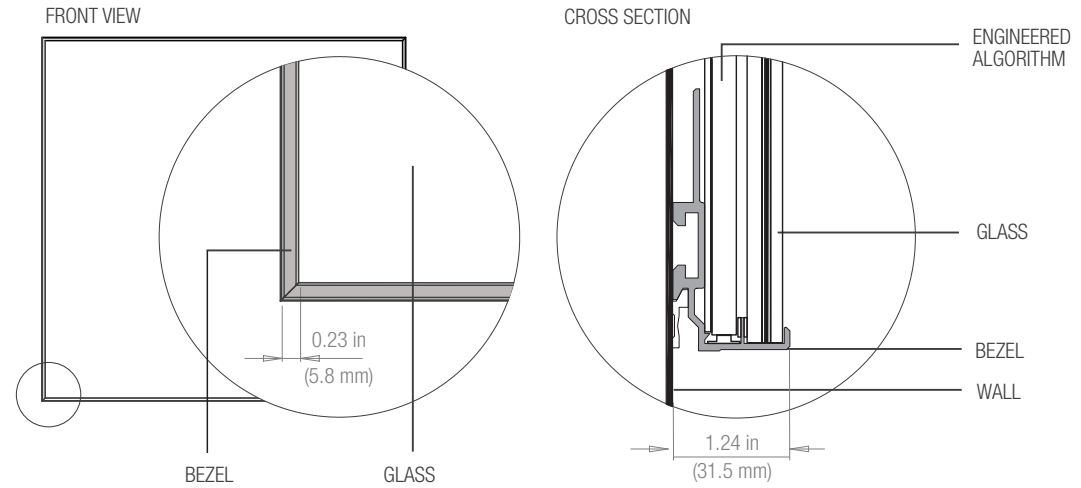

left to right: LightPlane Panels in ViviSpectra Elements glass, custom Black Fig interlayer, Standard finish shown in a LEVELe-105 Elevator Interior with customized panel layout | LightPlane Panel in ViviGraphix Graphica glass, Cairo interlayer in White, Pearlex finish, shown in a LEVELe-105 Elevator Interior | LightPlane Panels in ViviSpectra Elements glass, custom Yucca Blue interlayer, Standard finish shown in a LEVELe-107 Elevator Interior with customized panel layout



3





Stainless Steel Elevator Doors in Stainless Steel, Sandstone finish, Dallas Impression pattern. Indianapolis International Airport, Indianapolis, Indiana.



elevator doors



Elevator doors are the perfect way to carry a design theme across a property, from elevator interior to elevator lobby and beyond. Included within this group are door skins for elevator car doors and hoistway doors in a variety of materials, finishes and patterns.



STAINLESS STEEL & FUSED METAL

Elevator Door Skins in stainless steel and five Fused Metal colors – Fused Bronze, Fused Graphite, Fused Nickel Bronze, Fused Nickel Silver and Fused White Gold – create a striking design statement. Finishes include High-Durability and standard options. Patterns draw from our Impression and Eco-Etch palettes and add visual interest while helping conceal the occasional surface blemish.

Door Skins typically serve as both door face and edge detail and can be specified with an “L” shaped return or a “J” shape that returns around the back side of the door.

L-SHAPED RETURN

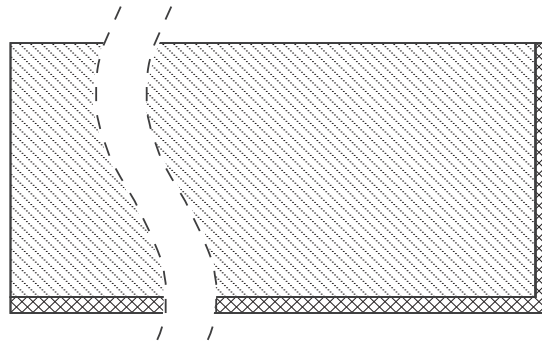

J-SHAPED RETURN

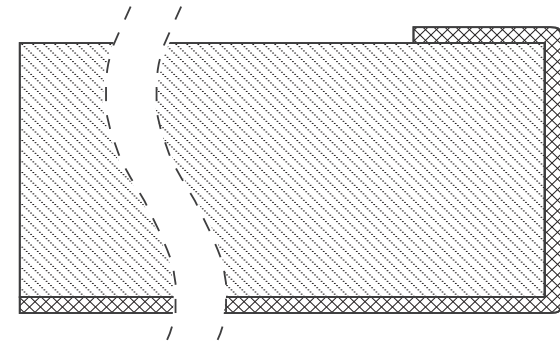

left to right: Stainless Steel, Seastone finish, Champagne Impression pattern | Stainless Steel, Mirror finish, ECO205H Eco-Etch pattern | Stainless Steel, Mirror finish, custom Eco-Etch pattern









BONDED METAL

Bonded Metal Elevator Door Skins offer exceptional resistance to abrasion and wear. Design options include a wide range of patterns, three colors – Bonded Aluminum, Bonded Bronze and Bonded Nickel Silver – and Natural and Dark Patinas.

Bonded Metal Elevator Door Skins typically use a formed metal trim piece that captures the edge of the Bonded Metal casting. Edge trim can be specified with an “L” shaped return or with a “U” shape that returns around the back side of the door.

L-SHAPED RETURN

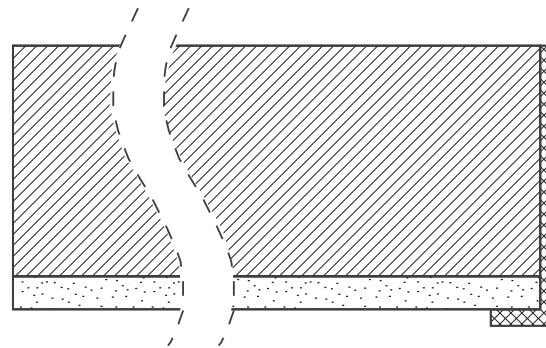

U-SHAPED RETURN

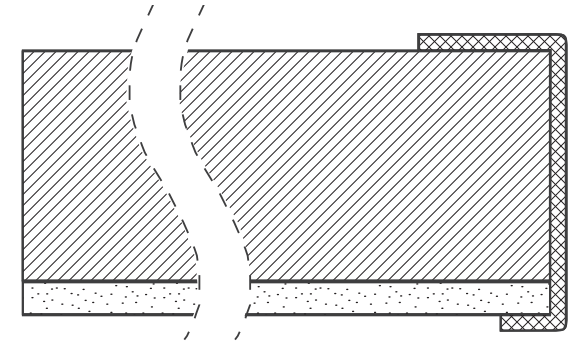

left to right: Bonded Bronze, Dark Patina, Charleston pattern | Bonded Bronze, Dark Patina, custom pattern | Bonded Nickel Silver, Dark Patina, Vancouver pattern





ELEVATOR DOOR APPLICATIONS



Bonded Metal Elevator Doors in Bonded Bronze, Dark Patina, Charleston pattern. Fontainebleau Miami Beach, Miami Beach, Florida. | Stainless Steel Elevator Doors in Stainless Steel, Sandstone finish, Dallas Impression pattern. Indianapolis International Airport, Indianapolis, Indiana. | Stainless Steel Elevator Doors in Stainless Steel, Mirror finish, custom Eco-Etch pattern. Renaissance Schaumburg Hotel & Convention Center, Schaumburg, Illinois.



Stainless Steel Elevator Doors in Stainless Steel, Satin finish, custom Eco-Etch pattern. Clackamas Community College - Harmony Campus, Milwaukie, Oregon. | Fused Metal Elevator Doors in Fused Bronze, Satin finish, custom Eco-Etch pattern. New York Life Insurance, Dallas, Texas.





surfaces

VividGlass. BermanGlass. Stainless Steel. Fused Metal. Linq Woven Metal. Bonded Metal. Bonded Quartz. Our Surfaces are the basis for unlimited creative expression. Beautiful on their own, they bring a robust visual vocabulary to elevator interiors and more. They are as diverse as the applications for which they are used. And, highly configurable like our Systems, they offer a sophisticated breadth of choices that can be tailored to meet the real-world challenges of today's public spaces. Shown here are just some of the hundreds of options. To see more, visit www.forms-surfaces.com.

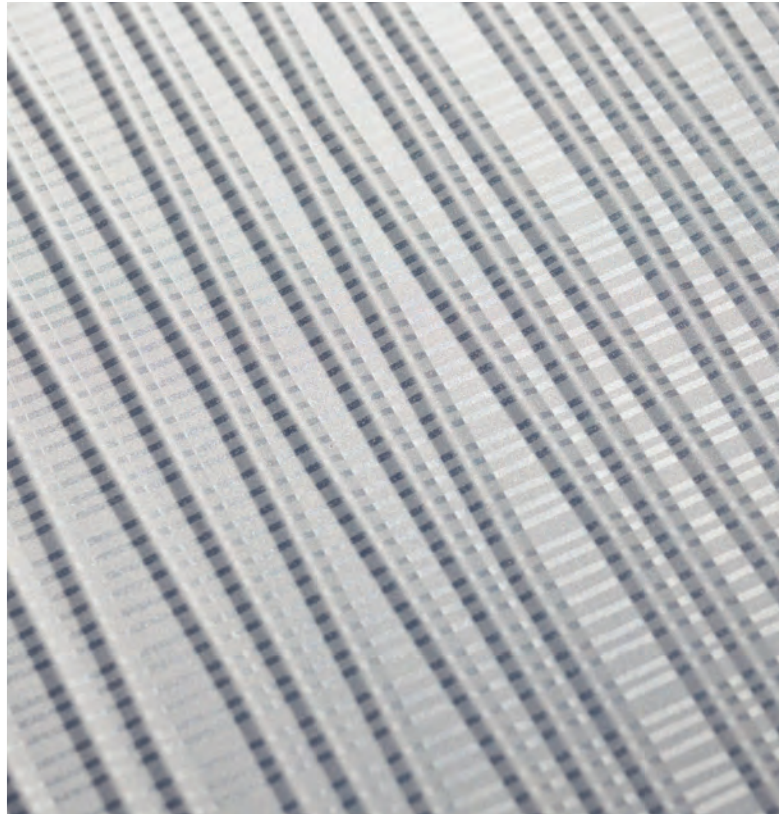

ViviTela Mesh glass, Framework interlayer in White Gold, Standard finish | Stainless Steel, Seastone finish, Cinch Fusion pattern | Fused Nickel Silver, Seastone finish, Sequence Eco-Etch pattern

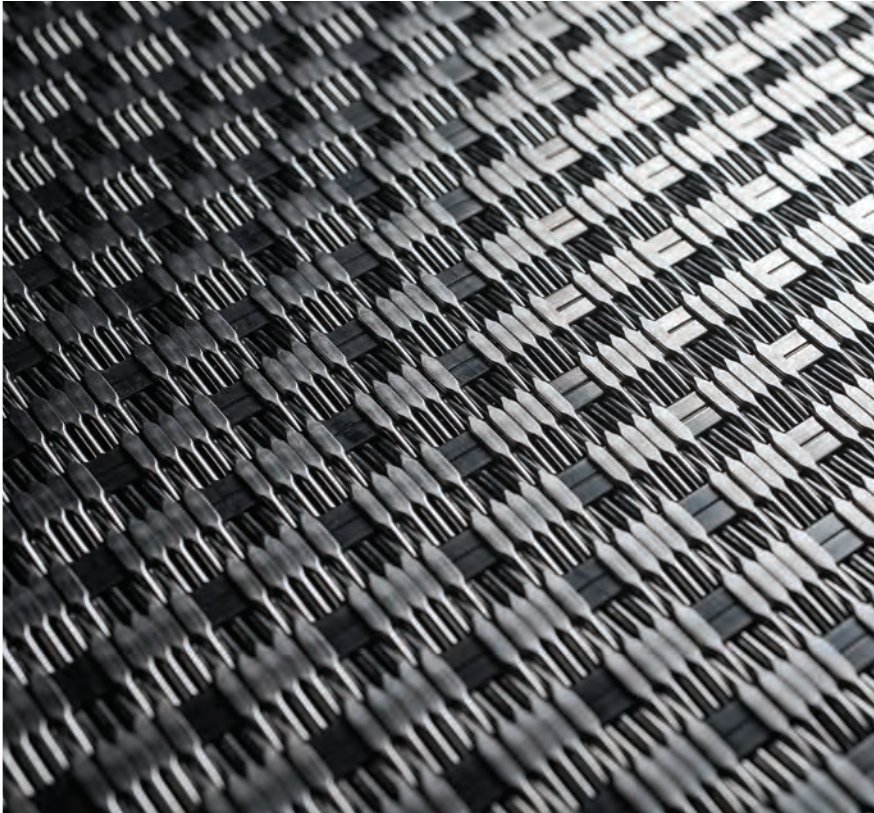

Linq Woven Metal, Stainless Steel, Rhythm pattern | Bonded Aluminum, Natural Patina, Talus pattern | American Walnut wood veneer





VIVIDGLASS

Offering unrivaled creative freedom, each F+S VividGlass laminated glass family is defined by its visual characteristics, with options ranging from solid colors and colored graphics to etched designs to customer-supplied logos, artwork and photography.

left to right/top to bottom: ViviGraphix Graphica, Glacier interlayer in White, Standard finish | ViviSpectra Elements, Marea interlayer, Standard finish | ViviGraphix Graphica, Cairo Interlayer in Taupe, Standard finish | ViviStone Opal Onyx, Standard finish | ViviStrata Layers, Glide interlayer in White | ViviChrome Chromis, Slate Blue interlayer, Opalex finish



ViviTela Mesh glass, Framework interlayer in White Gold, Standard finish.



BERMANGLASS

BermanGlass kiln cast glass expands the creative reach of the F+S glass program with artisanal sculptural textures. The Levels family is ideal for elevator interiors and beyond. Other BermanGlass families provide kiln cast beauty outside the cab.

left to right/top to bottom: Levels Kiln Cast Glass, Hikaru + Shadow design | Refract Kiln Cast Glass, Arrigado texture | Levels Kiln Cast Glass, Nuv'eau + Lagoon design | Classic Kiln Cast Glass, On-Wa texture | Intervals Kiln Cast Glass, Verse texture | Profile Kiln Cast Glass, Corduroy texture

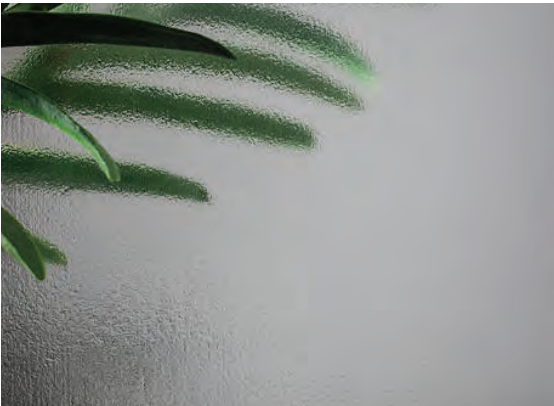
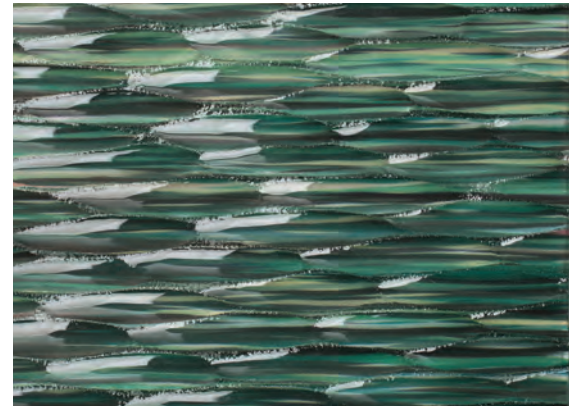







STAINLESS STEEL

Forms+Surfaces is the world's premier resource for architectural stainless steel—a material unmatched in quality and beauty. Our high-durability finishes and wide range of distinctive patterns offer limitless design and performance options for public spaces of all kinds.

left to right/top to bottom: Satin finish, Seagrass Eco-Etch pattern | Satin finish, Mica Eco-Etch pattern | Mirror finish, Thatch Eco-Etch pattern | Sandstone finish | Satin finish, Flicker Eco-Etch pattern | Satin finish, Dune Impression pattern

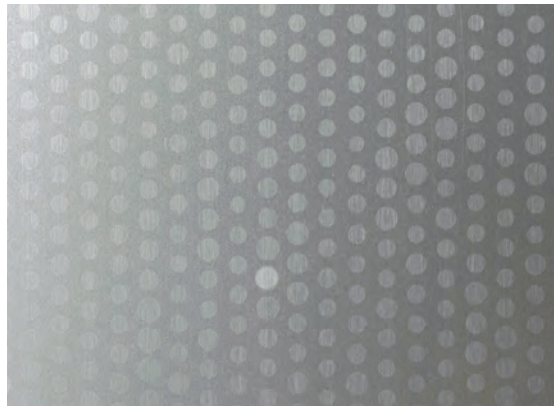
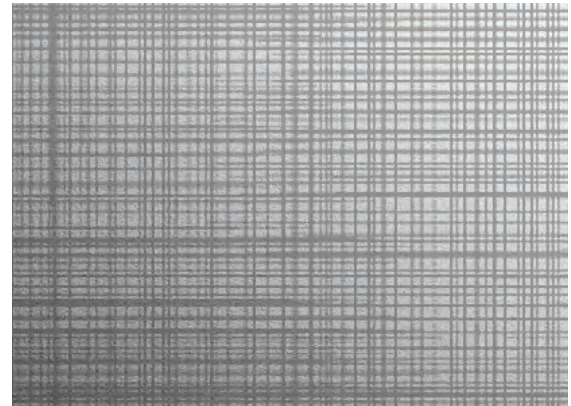

Stainless Steel, Seastone finish, Cinch Fusion pattern.



FUSED METAL

Fused Metal, our exclusive line of colored stainless steel, is created using vapor deposition technology to fuse titanium alloys at the molecular level to stainless steel substrates. Fused Metal provides the durability of stainless in a rich range of colors.

left to right/top to bottom: Fused Nickel Silver, Seastone finish, Denver Impression pattern | Fused White Gold, Mirror finish, City Lights Eco-Etch pattern | Fused Nickel Silver, Satin finish, Stacks Eco-Etch pattern | Fused Nickel Bronze, Satin finish, Trace Eco-Etch pattern | Fused Graphite, Seastone finish, Reeds Eco-Etch pattern | Fused Bronze, Satin finish

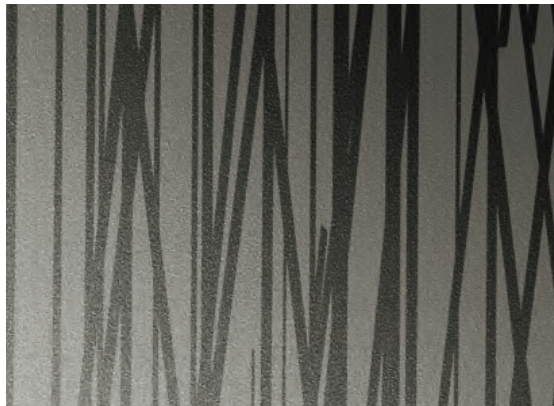
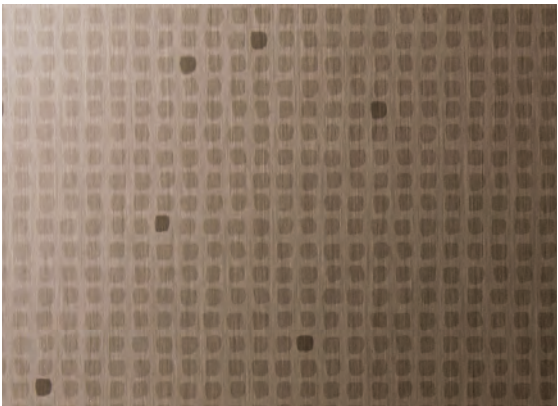
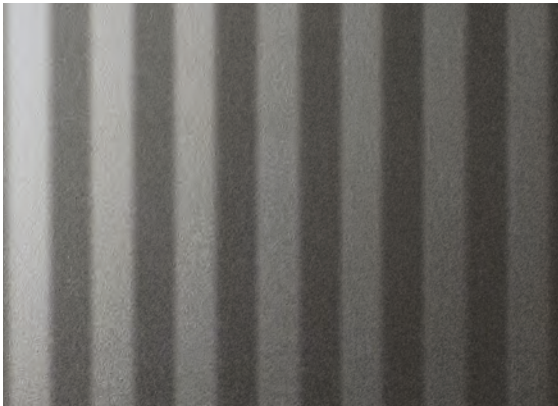

Fused Nickel Silver, Seastone finish, Sequence Eco-Etch pattern.

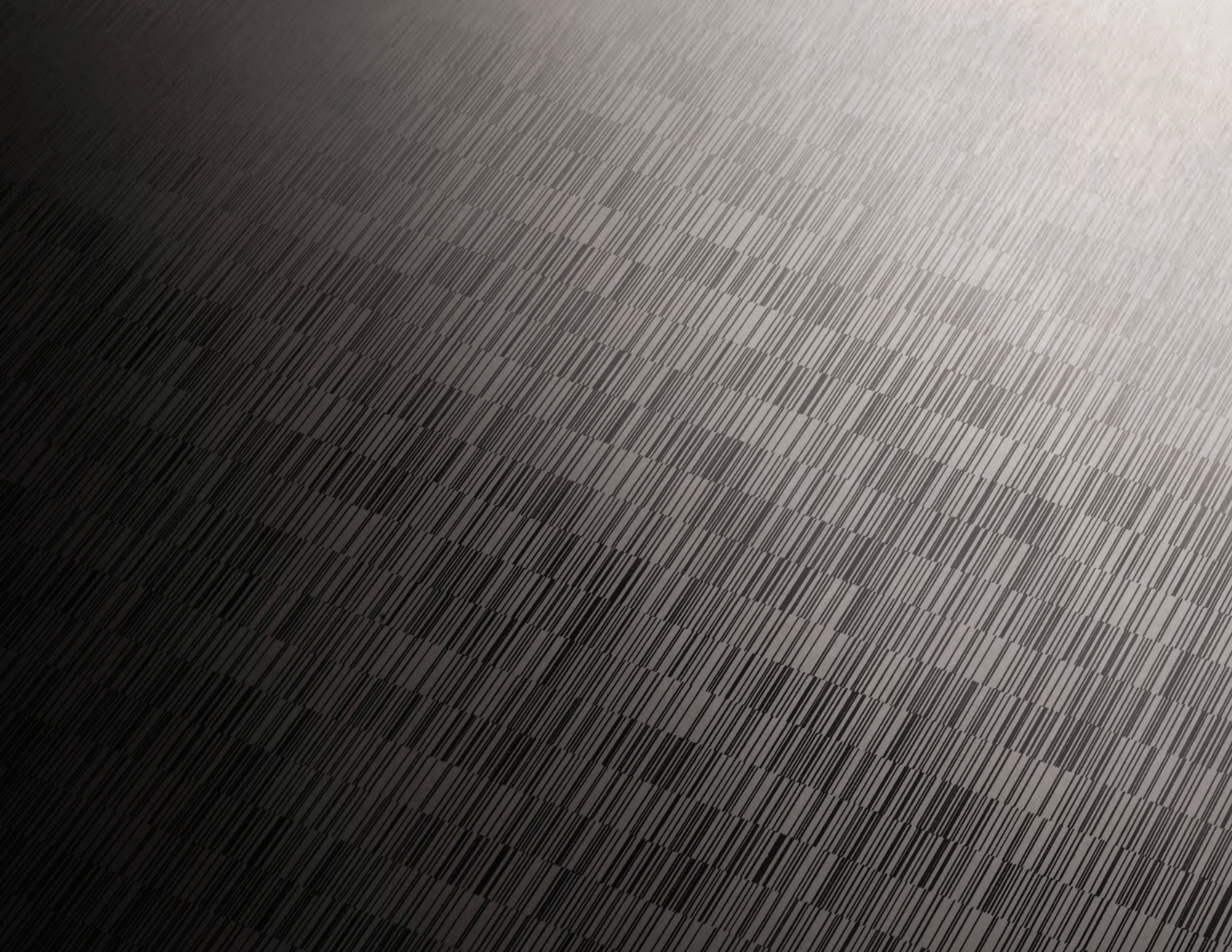

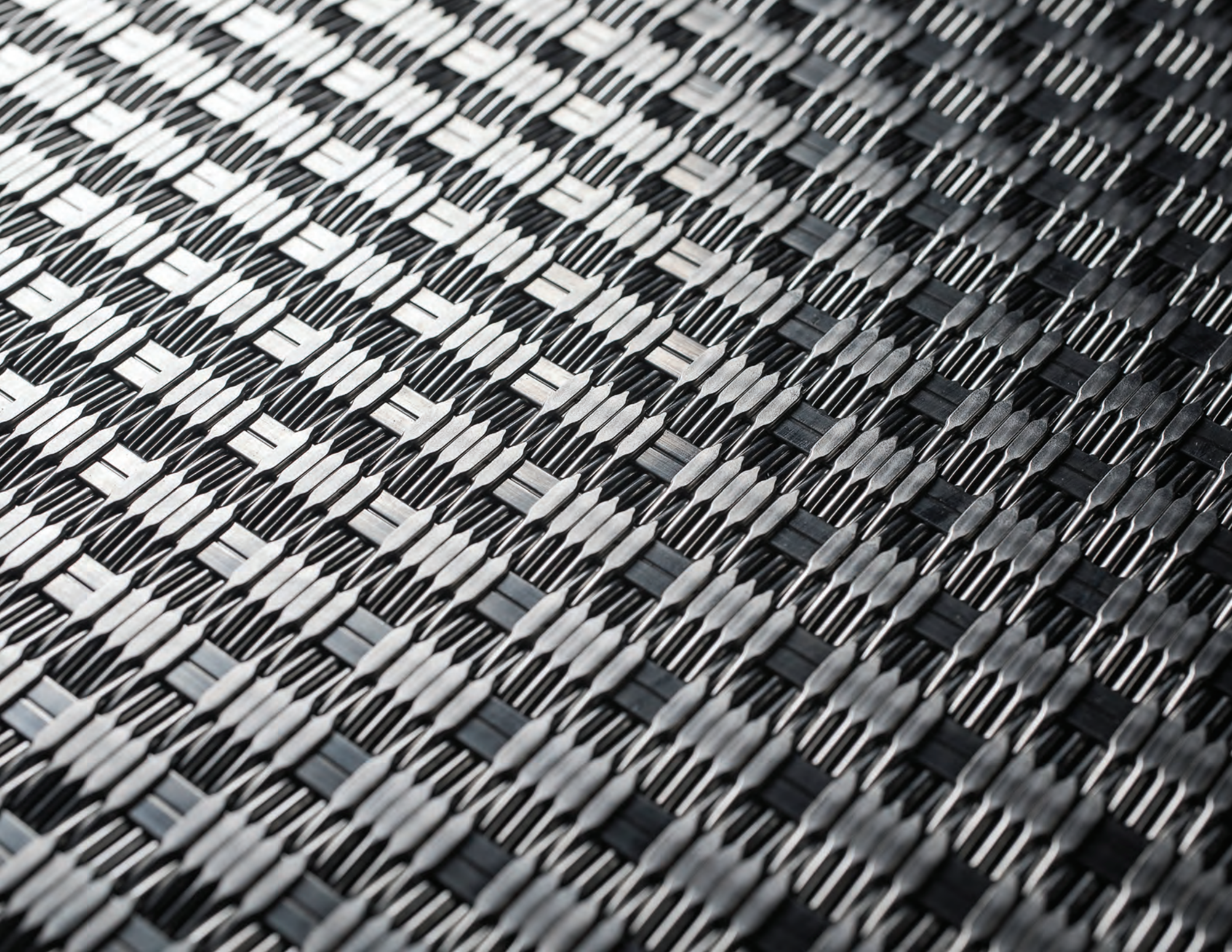



LINQ WOVEN METAL

Linq brings a distinctly F+S twist to woven metal and unites modern aesthetics, exceptional durability, and integration with our elevator interiors and more. Linq patterns interweave flat and/or round wires to create beautiful rigid textures and designs.

left to right/top to bottom: Brass, Wave pattern | Stainless Steel, Echo pattern | Stainless Steel, Dark patina, Merge pattern |
Stainless Steel, Rhythm pattern | Stainless Steel, Slope pattern | Brass, Sum pattern

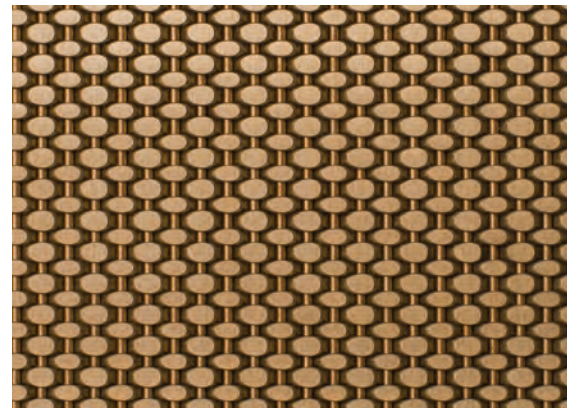
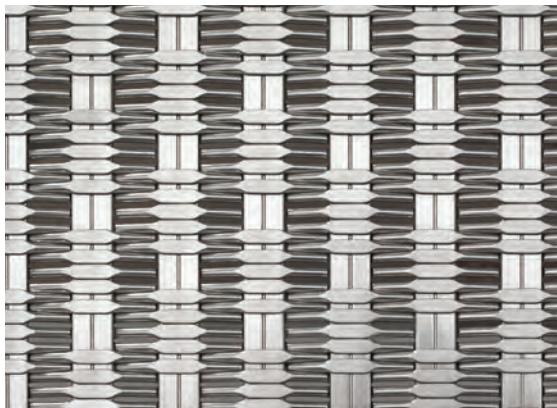
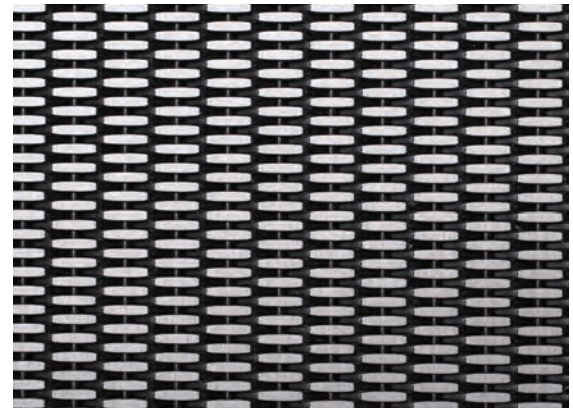
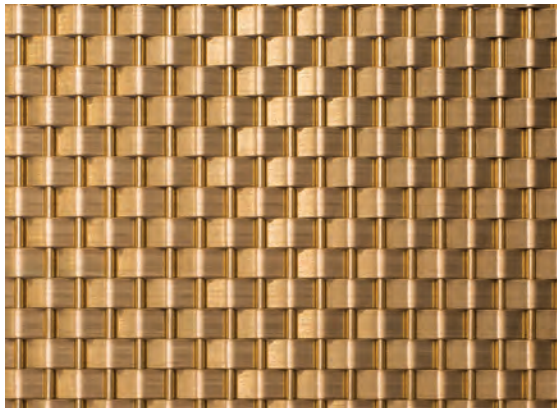

Linq Woven Metal, Stainless Steel, Rhythm pattern.



BONDED METAL

Bonded Metal is a high-performance surfacing material that offers a wealth of design possibilities. Metal granules cast in a tough FRP matrix result in castings that are lightweight, extremely durable and have the character and appearance of solid metal.

left to right/top to bottom: Bonded Bronze, Natural Patina, Grass pattern | Bonded Aluminum, Dark Patina, Trevia pattern | Bonded Bronze, Dark Patina, Charleston pattern | Bonded Nickel Silver, Dark Patina, Dash pattern | Bonded Nickel Silver, Natural Patina, Kalahari pattern | Bonded Aluminum, Natural Patina, Waterfall pattern

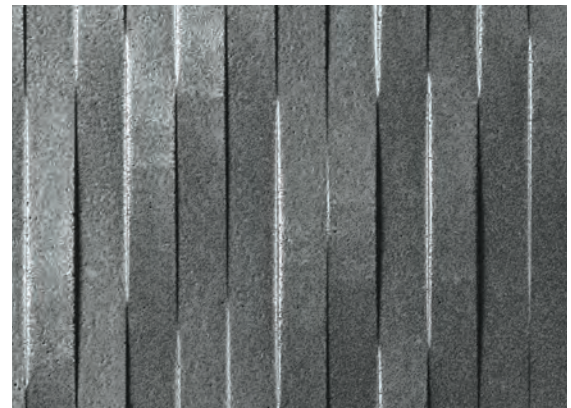
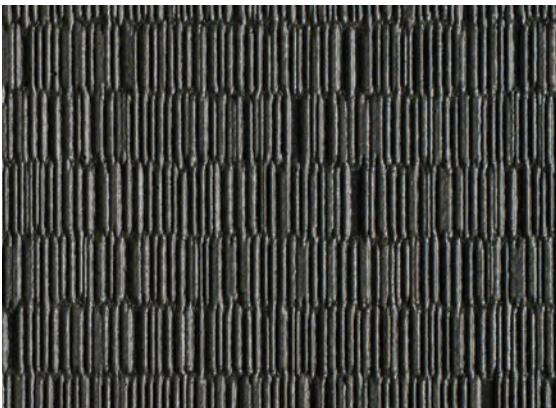
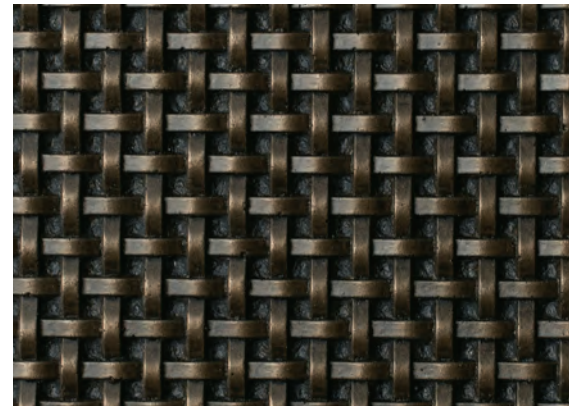
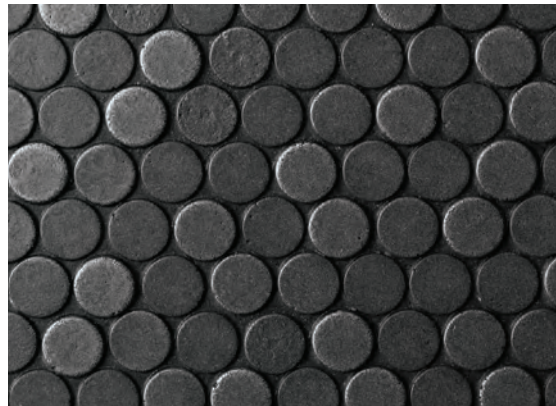
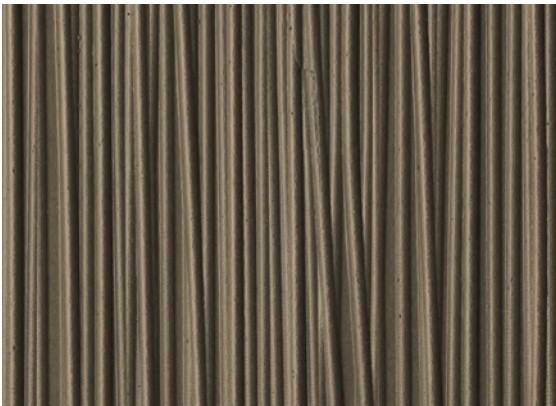

Bonded Aluminum, Natural Patina, Talus pattern.







BONDED QUARTZ

Bonded Quartz brings a contemporary look to interior settings. Ceramic microspheres in a tough FRP matrix create durable lightweight castings with integral color, a stunning appearance and a surface that's easy to clean.

left to right/top to bottom: Bonded White, Crinkle pattern | Bonded White, Glint pattern | Bonded Charcoal, Carbon pattern | Bonded Charcoal, Loft pattern | Bonded White, Waterfall pattern | Bonded White, Current pattern

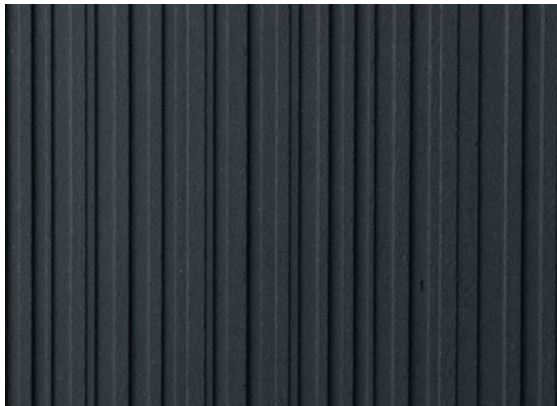

Bonded Quartz, White, Grass pattern.



WOOD VENEER

Our natural wood veneers are finished with three coats of polyurethane for superior abrasion resistance while maintaining the richness and authenticity of genuine wood.

left to right/top to bottom: Birdseye Maple | White Birch | American Cherry with Dark Mahogany Stain | American Cherry | Walnut Burl
| Australian Lacewood | Wenge | Bamboo

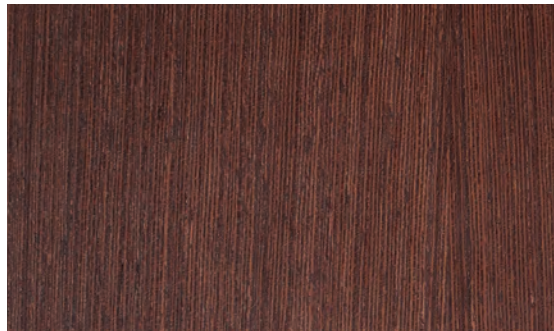
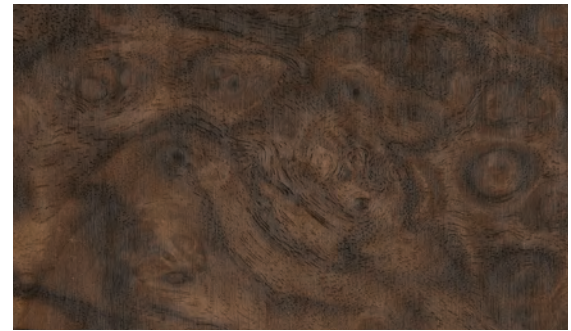
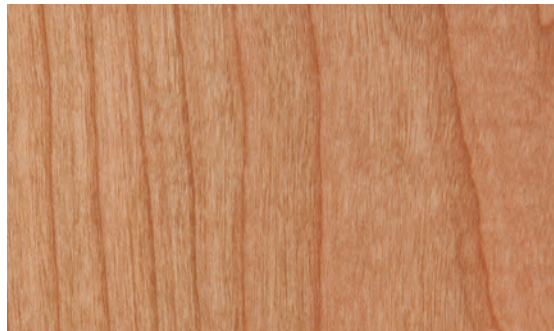
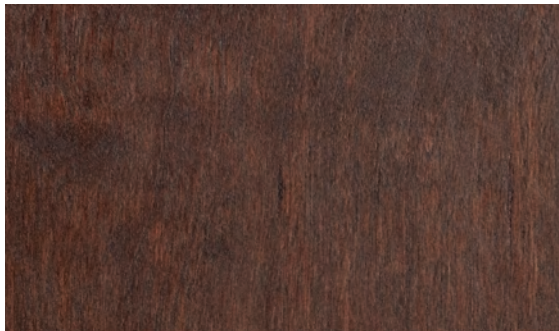

American Walnut wood veneer.





ELEVATOR DESIGN STUDIO
A FORMS+SURFACES DESIGN TOOL

DESIGN. VISUALIZE. SPECIFY.

Forms+Surfaces' Elevator Design Studio is an interactive tool that puts design control at your fingertips. The intuitive, step-by-step format lets you choose an elevator interior configuration, apply materials and finishes from our extensive Surfaces library, view your progress in realistic renderings, and request budget pricing—all with a few simple clicks.

Register now, or log in to your account to experience the benefits of working with the Elevator Design Studio. Registration is fast, secure, and the first step in beginning your creative journey.

[REGISTER NOW](#)

©2018 Forms+Surfaces





design tools

Use our Design Tools to bring your creative vision to life. Each application in this growing collection blends sophisticated design functionality with an intuitive, easy-to-use interface. Four interactive tools – our Elevator Design Studio, Virtual Quarry, Zoom Digital Darkroom and VEKTR Digital Canvas – let you explore ideas, build your designs, share your projects, and request budget pricing.

You'll find all of these tools, plus more to come, on our website: www.forms-surfaces.com.



ELEVATOR DESIGN STUDIO

The Elevator Design Studio (EDS) makes it easier than ever to bring your elevator interior designs to life.

Unparalleled in its reach, the EDS is a comprehensive, time-saving visualization tool that helps you creatively tailor our Surfaces and Elevator Interiors to your project-specific needs.

The intuitive step-by-step format lets you choose your elevator interior configuration, apply materials and finishes from our extensive Surfaces palette, save selections to your 'Favorites' library, work through design ideas, and view your progress in realistic renderings. You can also manage your projects, share your work and request budget pricing – all with a few simple clicks.

Try it and you'll see how easy it is to bridge the gap between creative vision and installed reality.

Get started at www.elevatordesignstudio.com

A **FORMS+SURFACES** DESIGN TOOL Log out | My Account | New Project

CONFIGURATIONS WALL PANELS HANDRAILS CEILINGS REVIEW

LEVEL-103 | DESIGN REVIEW: Your elevator design is complete. At right, you can see how it looks. Below, you can designate LightPlane Panels (if appropriate), and provide additional details (optional). Finally, you can choose where to go from here: download a PDF of your design; begin a new design; or go to your 'Projects' folder.

GENERAL HOSPITAL WEST WING ELEVATOR INTERIOR #1 (edit)

PANEL FRAMES
If applicable, select one of two panel frame options below.
NOTE: Capture panel frames will be used by default with VividGlass and some Bonded Metal or Bonded Quartz.

 0.11 m (2.8 mm)
MINIMAL PANEL FRAME

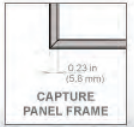
 0.23 in (5.6 mm)
CAPTURE PANEL FRAME

ADDITIONAL DETAILS
These details are not mandatory at this stage to complete your design. However, you will need to provide dimensions to request budget pricing. You can do this now or in the future.

+ DIMENSIONS

D1 DEPTH: inches

W1 WIDTH: inches

H1 CAB SHELL HEIGHT: inches

H2 CEILING HEIGHT: inches

+ MORE DETAILS (Click to expand)



FOR FUTURE UPDATES OK Terms of Use Privacy Policy Site Map ©2012 Forms+Surfaces forms-surfaces.com

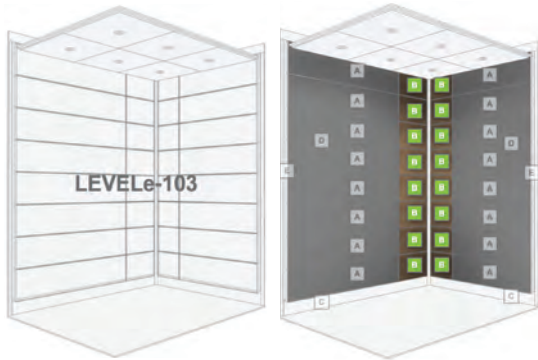

STEP 1: Configuration selection

STEP 2: Wall Panel selection



STEP 3: Handrail selection

STEP 4: Ceiling selection



Stainless Steel, Seastone finish



American Walnut wood veneer



Round handrail in stainless steel

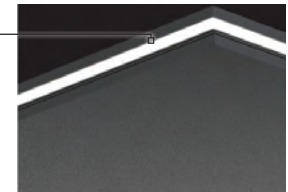

Ceiling with LED perimeter lighting



VIVISTONE VIRTUAL QUARRY

The Virtual Quarry is a remarkable online application that allows you to configure your ViviStone designs. The Virtual Quarry makes it easy to unleash your creativity, free from the physical constraints of real stone, and transform elevator interiors and projects of all kinds with our state-of-the-art ViviStone glass.

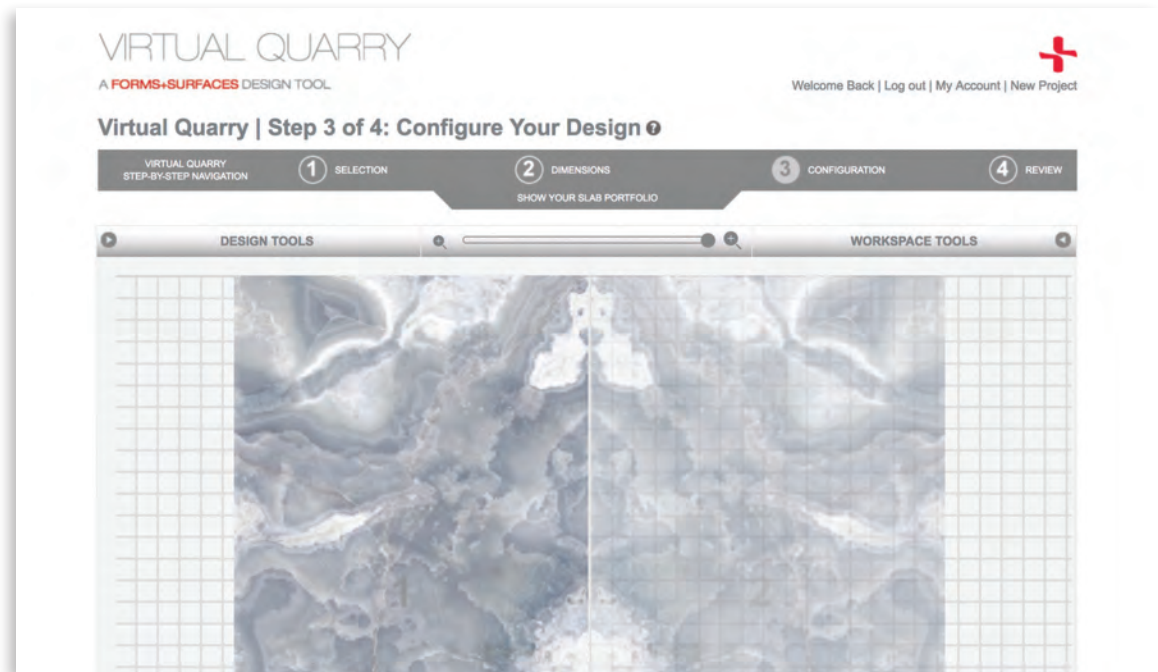
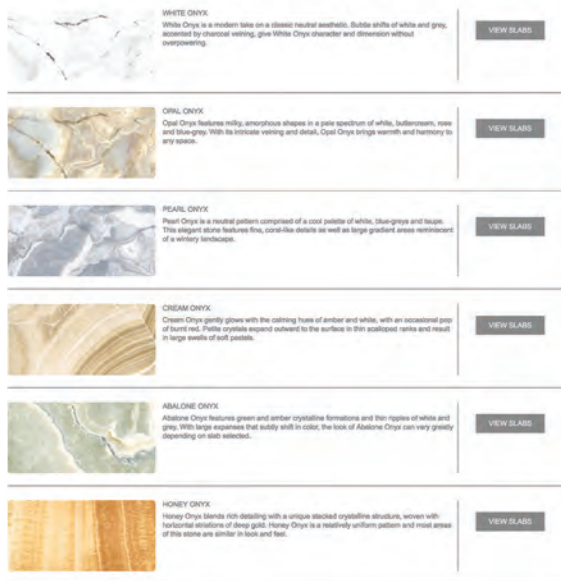

This project used the "Bookmatch" feature to create two mirrored Pearl Onyx LightPlane Panels installed in the LEVELe-106 Elevator Interior at right.



From the Virtual Quarry you can select from our families of ViviStone slabs, assemble and configure your designs, work on multiple projects simultaneously, share your ideas with colleagues or clients, and request budget pricing – all from within a single application.

Try it for yourself at www.virtualquarry.com

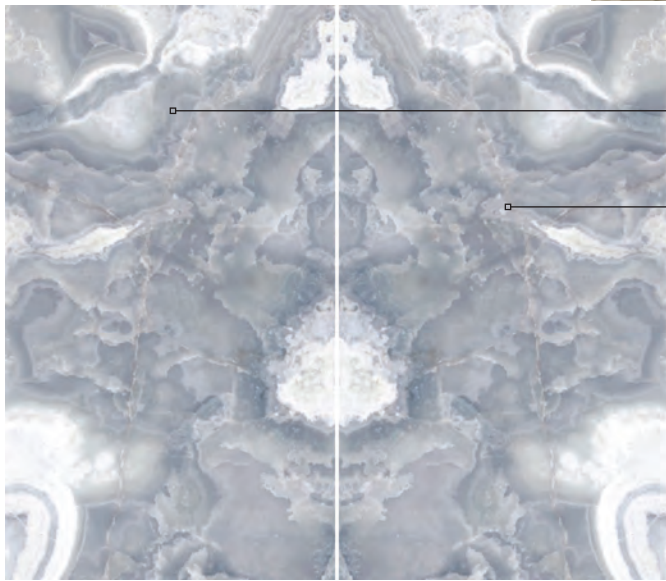



ZOOM DIGITAL DARKROOM

The Zoom Digital Darkroom makes it easier than ever to bring nature's beauty to large-scale glass applications and transform public spaces of all kinds with stunning high-resolution photography of the natural world. This dynamic design tool builds on the photographic capabilities of our ViviSpectra glass, offers incomparable customization potential, and gives you infinite ways to zoom into a photo to discover art within the bigger picture.

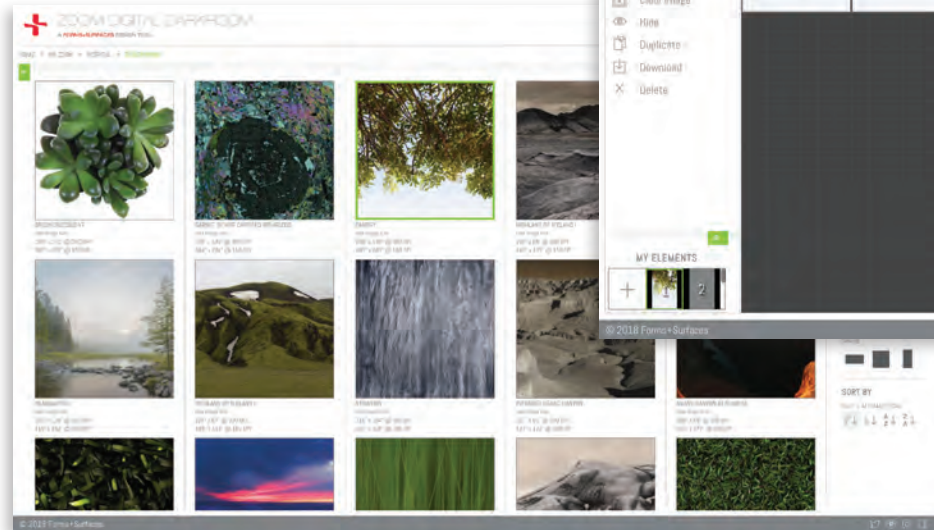

Use the Zoom Digital Darkroom to add a unique photographic dimension to elevator interiors, walls, columns, and all of your architectural glass projects.



Part interactive design studio, part curated photo library, the Zoom Digital Darkroom gives you access to Zoom images – our growing collection of large-scale, super-high-resolution photos created using sophisticated gigapixel image capturing equipment. It also gives you the tools you need to get creative with these photos: you can browse images, size, scale and crop your selections, zoom in and out, configure designs, and request budget pricing— all from within the app.

Zoom in today: www.zoomdigitaldarkroom.com



Zoom images bring the beauty of nature to any space. Browse the Zoom photo library and you'll find literal and abstract views of a wide range of natural scenes: dramatic seascapes, vast mountain ranges, dappled forests, and extraordinary slices of the world around us.



VEKTR DIGITAL CANVAS

The VEKTR Digital Canvas (VDC) gives you the freedom to transform digital images of any size, from any source, into highly customized ViviSpectra VEKTR glass designs—all in a matter of minutes. Simply capture the shot you want, drag it into the app, and start designing. The VDC converts raster images of any size into infinitely scalable, customizable vector artwork—referenced in the VDC as a 'canvas'. Each canvas generates a unique file that's output as the interlayers in ViviSpectra VEKTR glass.

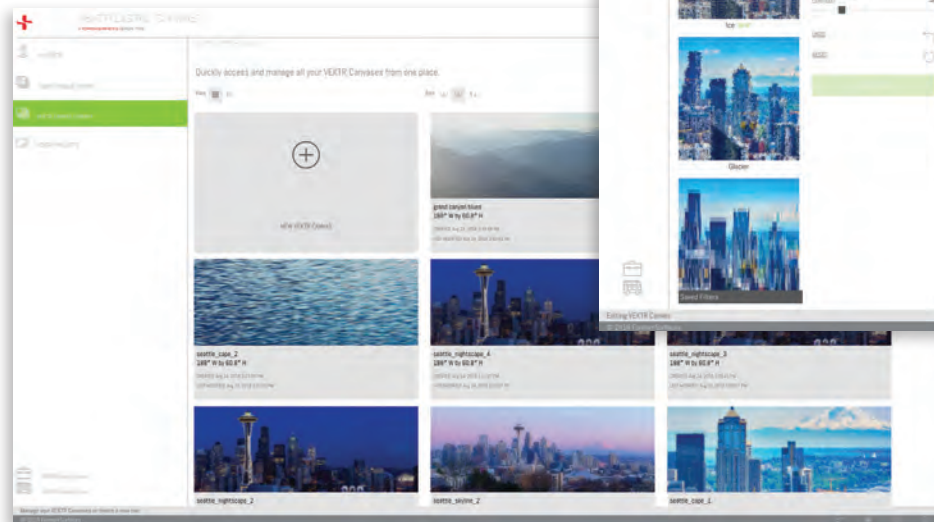

The VDC gives you endless ways to bring your own imagery to elevator interiors and more.



Within the VDC, canvas patterns, colors and dimensions are fully customizable. You can experiment with filters, colors and abstraction levels, visualize canvases in 2D and 3D, view your progress in live renderings, download and save your work, request budget pricing, and go from start to finish without leaving the app.

Capture the potential at www.vektrdigitalcanvas.com

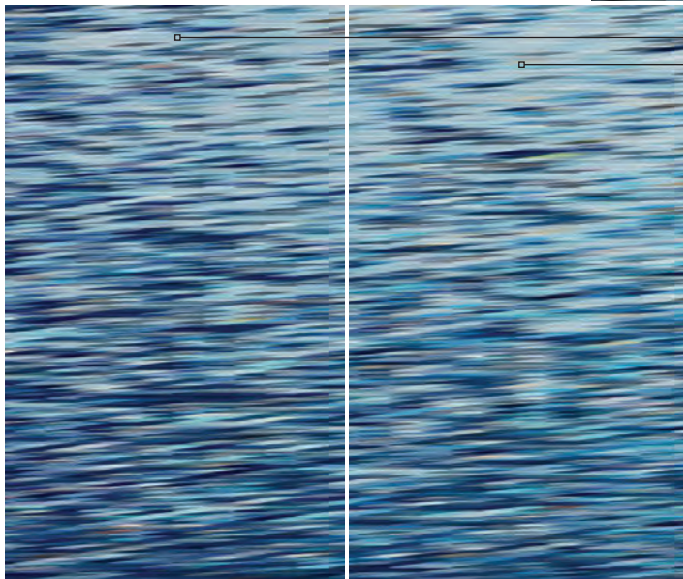

Opt for a literal view, go for something completely abstract, or both—with the VEKTR Digital Canvas, the choice is yours.



COMPREHENSIVE SUPPORT

Systems that Invite Creativity

All of our Systems products, including elevator interiors and elevator doors, balance the convenience of a standardized system with impressive design flexibility. Our Systems let you move seamlessly from bold new concept to installed reality by:

- Providing a framework for our Surfaces: with literally hundreds of material and finish combinations to choose from, you benefit from countless design options as well as the cost-efficiencies of using our Surfaces in our Systems, and vice versa.
- Addressing mechanical details: those you see, like trim pieces and other finishing elements, and those you don't, like attachment systems and mounting assemblies. This gives you the freedom to focus on designs and finishes, while saving on the time and costs associated with custom solutions.
- Offering project-specific technical support that can help you with:
 - Shop drawings and project detailing
 - Material yields
 - Weight calculations
 - Mounting and installation details
 - Budget pricing early in the process

Interrelated Product Lines

Our interrelated product lines make it easy to carry design and material themes across a property.

Within our line you'll find:

Surfaces – as introduced on the preceding pages, an extensive palette of materials, finishes and patterns that can be specified as sheet goods or incorporated into many F+S products.

Systems – the Elevator Interiors and Elevator Doors shown here, along with Wall Cladding, Columns, LightPlane Panels and Information Displays.

Doors – Expertly crafted designs in a variety of sizes, styles and materials for entry ways and interior passages.

Door Pulls – sculptural and linear profiles in a full range of sizes to complement our doors, as well as our elevator handrails.

Site Furniture – a versatile group that includes benches, bike racks, litter & recycling receptacles, planters, tables and chairs.

Outdoor Lighting – contemporary designs, precision craftsmanship, and LED technology shape our collection of bollards and pedestrian fixtures.

Time-Tested Expertise

We recognize that every project is unique, and that multi-faceted projects require an array of talents and capabilities.

For nearly five decades, we've worked with our clients to develop real-world product solutions.

We've also invested steadily in high-end manufacturing facilities and equipment, innovative materials and finishes, and the skilled professionals that make up our team.

So, whether you're navigating building code requirements, ADA guidelines or environmental issues, we're here to support you at every step in the process by giving you access to:

- Unparalleled manufacturing expertise
- State-of-the-art technologies and materials
- Decades of industry experience
- Products with proven performance in demanding environments
- Knowledgeable employees around the world who can assist you with design and engineering challenges, project management, sustainability compliance, and technical and customer support



ADDITIONAL RESOURCES

Visit Our Website: www.forms-surfaces.com

Updated regularly, our website is a comprehensive resource designed to help you discover what's new and stay up-to-date on product and company developments. In support of all of our Systems and Surfaces, you'll find:

- + Product Data Sheets & Design Guides
- + Full-sheet Pattern Drawings
- + Technical Specs
- + Installation Instructions
- + Environmental Data
- + Image Galleries
- + Project References

Contact Us

Contact Forms+Surfaces for additional information about any of our products or to reach a sales representative in a territory near you.

- + Telephone: 800.451.0410
- + General Inquiries:
marketing@forms-surfaces.com
- + Sustainability: green@forms-surfaces.com

Sign up for Forms+Surfaces new product announcements at www.forms-surfaces.com/news

U.S. LOCATIONS

Pennsylvania

30 Pine Street
Pittsburgh, PA 15223
P 800.451.0410
P 412.781.9003
F 412.781.7840

California

5055 6th Street
Carpinteria, CA 93013
P 800.451.0410
F 805.684.8620

Arizona

1025 North 71st Avenue
Phoenix, AZ 85043
P 800.451.0410
F 623.594.6312

INTERNATIONAL LOCATIONS

UK / Europe

88 Kingsway
London WC2B 6AA
P +44 203 755 3731
F +44 207 841 1001

India

Office No. 104, Pentagon 4,
Magarpatta City, Hadapsar,
Pune 411028, MH, India
P +91 20 67482400

Middle East

Suite B 307, Dubai, Silicon Oasis
PO Box 341052, Dubai, UAE
P +971 4 501 5605
F +971 4 501 5606

Middle East

Level 2, Louis Vuitton Building
Suite 2029, Allenby Street
Beirut, Lebanon
+961 1 957540

Thailand

37th Floor, Sathorn
Square Office Tower
98 North Sathorn Road Silom,
Bangrak, Bangkok 10500 Thailand
P +66 2 105 6447
F +66 2 105 6301

Taiwan

No. 18, Ln. 238, Gongye Road
Longjing District,
Taichung City 434,
Taiwan (R.O.C.)

Singapore

60 Kaki Bukit Place,
#02-10, Eunos Tech Park
Singapore 415979
P +65 6748 8383
F +65 6441 1185

Hong Kong

11/F, AXA Centre,
151 Gloucester Road,
Wanchai, Hong Kong
P +852 25823742
F +852 30113864

IMPORTANT: The surfaces shown in this catalog are intended as a visual guide. Because photographic reproduction may not present true product colors, actual finishes may vary slightly from the colors shown here.

FORMS+SURFACES®



We maintain an Environmental Management System and are continually working to improve our impact through efficiency, material selection, vendor education, employee involvement, and an unwavering commitment to being exemplary corporate citizens. If you would like additional information on our Environmental Management System or our company environmental initiatives and policies, please feel free to contact our Sustainability Team at green@forms-surfaces.com.

offices worldwide | 800.451.0410 | 412.781.9003 | www.forms-surfaces.com

Member of the USGBC | LEED® Accredited Professionals on Staff | FSC® Certified Supplier | FSC-C004453 | SCS-COC-001461 | © 1996 Forest Stewardship Council A.C.

 Printed on 50% recycled, 25% post consumer paper

FSELEVBRO-0119-3500-REV004